



# *X2 Wave Flamer*

*Manual 2.0*

*As of December 2018*

*Software version v1.59*

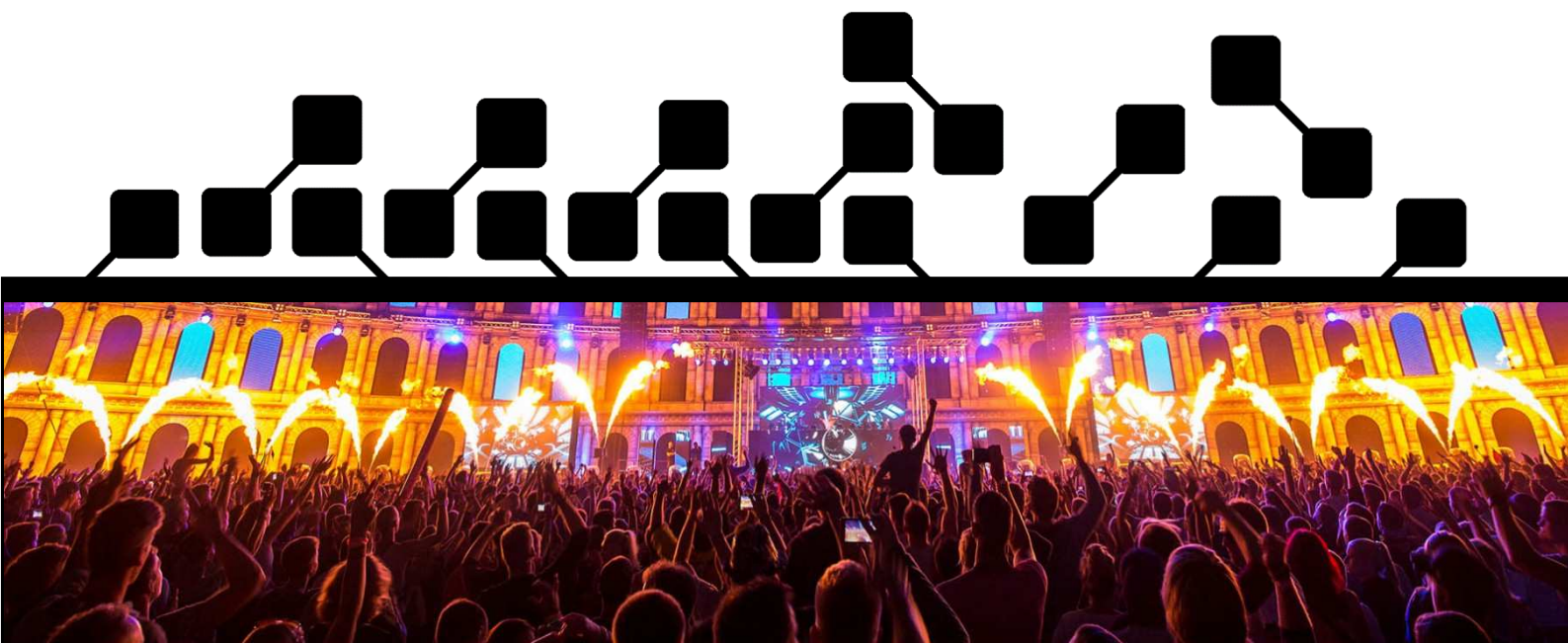

# PREAMBLE

Dear Explo customer,

Please read through these instructions carefully before using the devices. It contains many informations which will help you in getting to know your system.

	<p><b>Reading through this manual will support you in a responsible use of this product.</b></p>
---	--

We ask you to follow the safety- and usage tips provided by us.

Should you have any questions, or should there be any unclarities, which this manual cannot answer, please do not hesitate to contact us via E-Mail or by phone.

We hope you'll have fun with your new ignition system,

*Your Explo Team*

# INDEX

1 Overview of the X2 Wave Flamer.....	5
1.1 Function of the Wave Flamer.....	5
1.2 Areas of usage and possibilities .....	5
2 Receipt of goods.....	5
3 Components of the X2 Wave Flamer .....	6
3.1 Standard-Variant (Front).....	6
3.2 Standard variant (TOP).....	7
3.3 Head Variant without internal pumping unit (Front).....	8
3.4 Head Variant without internal pumping unit (Side) .....	9
3.5 Description of Components .....	10
4 Menu items .....	13
4.1 Main menu .....	13
4.2 Wave Flamer Settings.....	18
4.3 DMX-Settings .....	23
5 General, Definitions .....	24
5.1 Definition audience side.....	24
5.2 Definition Positions .....	25
6 Planning an preparing a show.....	25
7 Positioning and preparation at the show location.....	26
7.1 Positioning of the devices .....	26
7.2 Power supply .....	26
7.3 Preparing for the show.....	27
8 Controlling the X2 Wave Flamers - Generals.....	27
8.1 Activation.....	27
8.2 Switching off.....	27
9 Manual control via radio .....	28
9.1 Preparing the manual ignition mode .....	28
10 Automatic control via radio (AutoShow) .....	29
10.1 Preparing the automatic ignition mode (AutoShow) .....	29

# 4

10.2	Preparing the ShowCreator Software .....	29
10.3	Setting ignition cues .....	31
10.4	Selecting an effect .....	32
10.5	Group boxes .....	33
10.6	Designating and using groups in the ShowCreator .....	34
10.7	Setting an opening time .....	39
10.8	Calculating the drive time.....	41
10.9	Transferring the show to your devices.....	41
11	Control via DMX 512 .....	41
11.1	Preparing the DMX-512-Mode .....	42
11.2	DMX-channels .....	42
11.3	Igniting via DMX.....	46
12	Control via Easy-DMX .....	46
12.1	Preparing the Easy-DMX-Mode .....	46
12.2	DMX-channels .....	47
13	Safety.....	48
13.1	Angle blockers .....	48
13.2	Safety features .....	49
13.3	Safety recommendation .....	50
13.4	Safety hints .....	50
13.5	Recommended safety distances.....	51
14	Storage and maintenance .....	52
15	Technical data .....	53
16	Accessories (available separately).....	53
17	Informations for useable fluids .....	53
18	Software updates.....	54

## 1 OVERVIEW OF THE X2 WAVE FLAMER

### 1.1 FUNCTION OF THE WAVE FLAMER

The flame projector X2 Wave Flamer is an effect device, used to create a moving flame effect of up to 10m height, and a vertical swivel radius of 210°.

The X2 Wave Flamer uses liquid fuels, like ISOPAR, Bioethanol or Isopropylalcohol, which are stored in an internal canister, and sucked into the system by an integrated pumping unit. A motorized swivel head ejects the fluid into the preferred direction.

The X2 Wave Flamer uses two solenoid valves to control the liquids flow, as well as an electrical high voltage spark to ignite the fuel.

### 1.2 AREAS OF USAGE AND POSSIBILITIES

The X2 Wave Flamer is suitable for indoor and outdoor shows. Its usages can vary from concerts and stage shows, to special effects for theatre productions and sports events (eg. Entering of the players during football or ice hockey), pure fire shows by fire artists, or in conjunction with regular fireworks.

Via DMX, or the explo radio control, the projector can be integrated into automated shows. This allows for a musical synchronous usage of the device.

The choice of different nozzles affects the effect height and different fluids the colouring of the flame effect.

5

## 2 RECEIPT OF GOODS

In rare cases, problems might occur due to damages from transport, so we ask you to check the goods for the following after receipt:

Checklist when getting your goods
Is the package damaged outside? (Take pictures!)
Are the goods damaged outside?
Are the goods fully functional?
Are all accessories delivered? (Antenna and power cable are in the back with the canister)

We would ask you to notify us of damages or missing articles. Retroactive reclamations cannot be taken into consideration unfortunately.

## 3 COMPONENTS OF THE X2 WAVE FLAMER

### 3.1 STANDARD-VARIANT (FRONT)



6

#### Components of the X2 Wave Flamer

1	Key switch	6	DMX-Connectors
2	Display and usage buttons	7	ON/OFF switch (Power)
3	Status-LEDs	8	Fuze 12VDC
4	Antenna socket	9	Power connector
5	Programming socket	10	Fuze 230VAC

### 3.2 STANDARD VARIANT (TOP)



7

Components of the X2 Wave Flamer	
1	Swivel head and electrical ignition
2	Internal 10L fluid canister
3	Lead through for external fluid canister
4	Level indicator

### 3.3 HEAD VARIANT WITHOUT INTERNAL PUMPING UNIT (FRONT)

8



#### Components of the X2 Wave Flamer

1	Key switch	7	ON/OFF switch (Power)
2	Display and usage buttons	8	Fuze 12VDC
3	Status-LEDs	9	Connector for external pumping unit
4	Antenna socket	10	Power connector 100-230VAC Neutrik True-1
5	Programming socket	11	Fuze 230VAC
6	DMX-connector		



### 3.4 HEAD VARIANT WITHOUT INTERNAL PUMPING UNIT (SIDE)

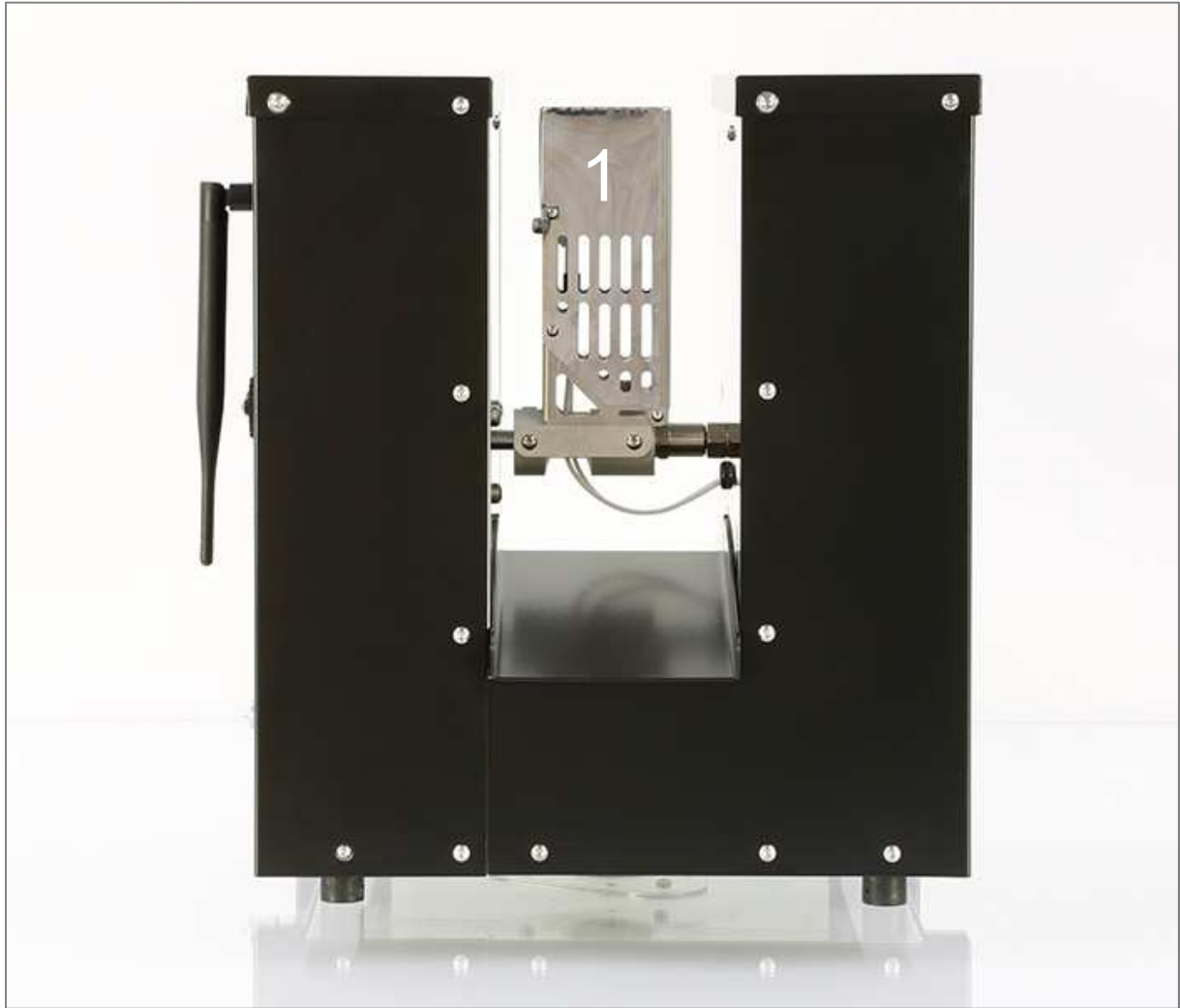

#### Components of the X2 Wave Flamer

- |   |                                     |
|---|-------------------------------------|
| 1 | Swivel head and electrical ignition |
|---|-------------------------------------|

## 3.5 DESCRIPTION OF COMPONENTS

### 3.5.1 KEY SWITCH

After switching on the power supply with the wip-switch (7), the projector can be activated. To activate the device, only short impulse via the key switch is needed. It can be turned off after activation. The Wave Flamer will remain switched on regardless.

This has an important function during a show in case of a power outage. If the key switch is in the ON position, the device will start up automatically after losing power. If it is switched off however, the device will remain powered off too after getting the power back.

### 3.5.2 DISPLAY AND USAGE BUTTONS

Via the display and the usage buttons, the most important values of the Wave Flamer can be seen, and the menu be navigated through. Outside of the Menu, some buttons have special functions.

Usage buttons of the X2 Wave Flamers	
<b>Mode / OK</b>	<i>Outside the menu, this button is used to access the menu. Inside the menu, this button is used to confirm. If held during startup of the Wave Flamer: Wave Flamer will start in radio mode.</i>
<b>E / Minus</b>	<i>Outside the menu this button is used to de-pump. If the device is armed, it will be switched into test mode too. Inside the menu this button functions as a minus button.</i>
<b>Light / Plus</b>	<i>Outside the menu you can use this button toggle the background light on and off. Inside the menu it can be used as a plus button.</i>
<b>Test / ESC</b>	<i>Outside the menu this button can be used to send a test signal to the transmitter, to check radio connection (only in test mode). Inside the menu can be used as an escape button. If held during startup: Wave Flamer starts in DMX-Mode.</i>

### 3.5.3 STATUS-LEDS

Via the Status LEDs, different states of the Wave Flamer can be checked.

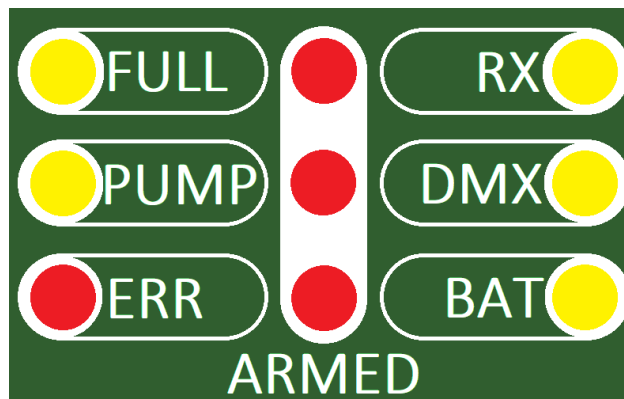

Status-LEDs of the X2 Wave Flamer	
<b>FULL</b>	Shows that the pumping unit has reached usage pressure.
<b>PUMP</b>	Is only lit if the pump is working. Should only be lit in armed-mode.
<b>ERR</b>	This LED indicates any errors with the device. If lit, the fuel canister may be empty. The Wave Flamer may not be used if this LED is lit, since it may lead to damages of the device. Please note the errorcode and contact the manufacturer.
<b>RX</b>	This LED flashes if a radio signal from the transmitter is received.
<b>DMX</b>	If DMX is integrated into the device, and is ready for use, this LED will be lit. If the projector receives DMX signals, it will flash for confirmation.
<b>BAT</b>	Shows the status of the power supply. If it is lit permanently, the power is okay. If it begins to flash, the device does not receive sufficient power. This may be caused by a defunct mains supply.
<b>ARMED</b>	The three middle LEDs are lit if the device is in armed-mode. During this time, be cautious when using the device, and make sure all safety distances are being adhered to.

### 3.5.4 ANTENNA SOCKET

A fitting antenna with BNC connector can be mounted to the BNC antenna socket for radio use. We recommend the use of original antennas.

The antenna is used to receive data. Pinching or breaking the antenna or its cable can lead to damages, and should therefore be avoided. During use, make sure that the antenna is safely mounted and placed upright, to guarantee the best possible radio reception.

Water or moisture entering the antenna socket can drastically decrease the radio reception.

### 3.5.5 PROGRAMMING SOCKET

Combined with the bootloader programming cable (sold separately) updates of the devices software can be made by yourself.

### 3.5.6 DMX-CONNECTORS

Via the 3 pole XLR connectors, a DMX controller can be connected to the Wave Flame. The outgoing socket can be used to forward the DMX signal to the next Wave Flamer.

Pin-configuration of the DMX-connector	
<b>Pin 1</b>	GND
<b>Pin 2</b>	B
<b>Pin 3</b>	A

### 3.5.7 ON / OFF SWITCH (POWER)

Allows you to switch the Wave Flamer's power supply on or off. After switching the wip switch on, the key switch must be at least switched on shortly, to start up the device.

---

### 3.5.8 FUZE 12VDC

10A delay action fuze for the internal 12VDC power supply.

---

### 3.5.9 POWER CONNECTOR

Allows you to connect the power supply of the Wave Flamer. The internal mains supplies are meant for 110VAC to 230VAC.

---

### 3.5.10 FUZE 230VAC

10A delay action fuze for the 230VAC power supply.

---

### 3.5.11 SWIVEL HEAD AND ELECTRICAL IGNITION

Here you can find the motorized swivel head of the Wave Flamer, as well as the socket for the nozzle and the electrodes for the electrical ignition.

---

### 3.5.12 INTERNAL 10L FLUID CANISTER

Only found in the standard variant. Here you can find the internal, reusable canister for liquid fuels. The maximum liquid capacity is 10 Liters.

---

### 3.5.13 LEAD THROUGH FOR EXTERNAL FLUID CANISTER

Only found in the standard variant. An extension hose (sold separately) can be lead through this opening and be attached to an external fluid tank.

---

### 3.5.14 LEVEL INDICATOR

Only found in the standard variant. Allows you to gauge the fuel level of the internal canister.

---

### 3.5.15 CONNECTOR FOR EXTERNAL PUMPING UNIT

Only found in the head variant without internal pumping unit. This special variant of the Wave Flamer, without internal canister and pumping unit, allows you to connect an external pumping unit via a fitting hose to the quick coupling at the front panel.

The maximum use pressure should not be higher than 14 bars.

## 4 MENU ITEMS

The menu of the Wave Flamer can be opened in test-mode with the Mode/OK button. The navigation through the menu is done with the Plus and Minus button. The Mode/OK button allows you to confirm. Exiting the menu can be done with the Test/ESC button.

The menu will close automatically after a minute of inactivity.

### 4.1 MAIN MENU

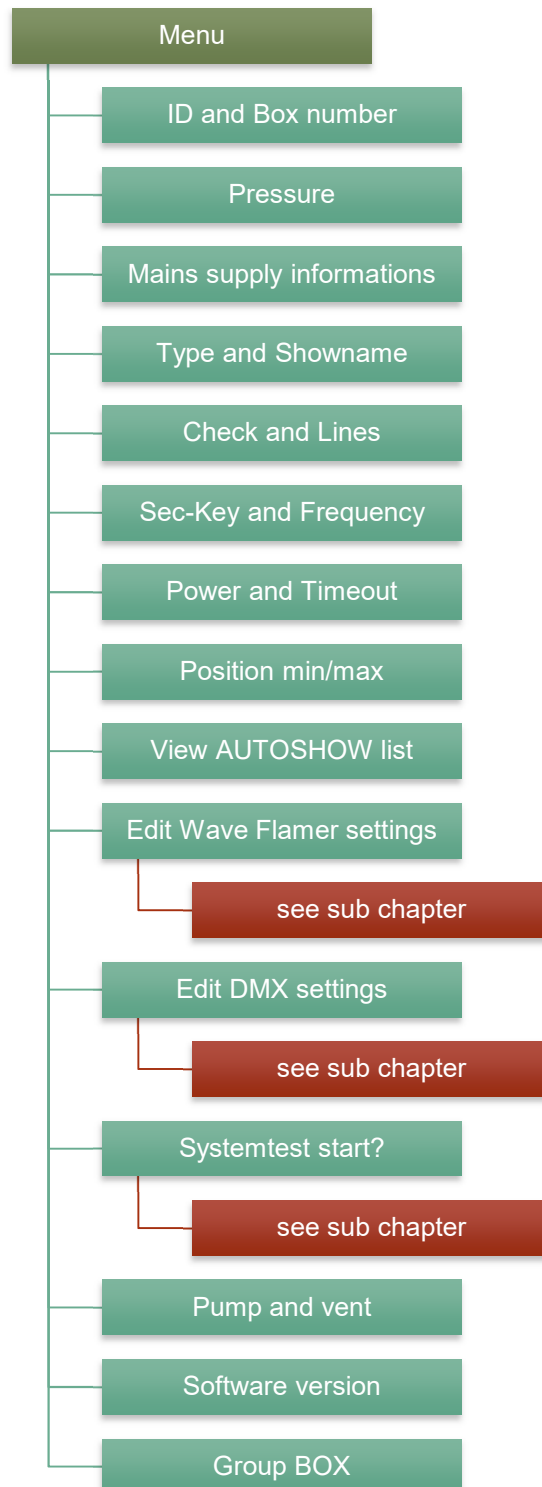

---

#### 4.1.1 ID AND BOX NUMBER



```
ID: 1403018
BOX: 5
```

Shows you the ID number (line 1) and the Box number (line 2) of the device.

---

#### 4.1.2 PRESSURE



```
PRESSURE 99% I
3.22sek u97% H
```

Shows the current pressure of the device in percent (line 1). Line 2 shows the time (in seconds) that the device needs to build up maximum pressure, as well as the lowest value the pressure has reached after getting to 100% (u97% means that the device has lost pressure to 97% after an ignition).

The letter at the end of the second line shows you if the pressure is set to Low (L), Medium (M), or High (H). This feature is currently not in use. The normally used setting is Medium.

---

#### 4.1.3 MAINS SUPPLY INFORMATIONS



```
Bat12: 13.81V
Bat24: 27.74V
```

Shows the power values of the mains supplies for the 12V supply (line 1), as well as the 24V supply (line 2).

---

#### 4.1.4 TYPE AND SHOWNAME



```
TYP: RXGAS
SHOW: new_show
```

Shows you the type of the product as it will be listed in the device list of the transmitter (line 1), as well as the name of the show currently saved on the device (line 2).

---

#### 4.1.5 CHECK AND LINES

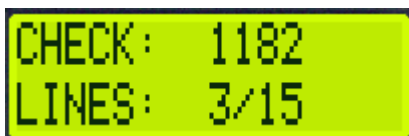

```
CHECK: 1182
LINES: 3/15
```

Shows you the Checksum of the device (line 1) and the number of ignition cues the current show has for the device (line 2).

---

#### 4.1.6 SEC-KEY AND FREQUENCY



SEC-KEY:139  
FREQ: 6

Allows you to see the set Secure-Key (line 1) and the set frequency of the internal radio module (line 2).

---

#### 4.1.7 POWER AND TIMEOUT



POWER: 10  
TIMEOUT:30sek

Here you can see the set radio power of the radio module (line 1) and the time after which the show will stop if no transmitter signal is received (line 2).

---

#### 4.1.8 POSITION MIN/MAX



POS Min:1  
POS Max:15

Shows the minimum and maximum positions the projector will drive to. In addition to this software solution, mechanical angle blockers are recommended. If such are used, the software must be set to the blocked angles too however.

---

#### 4.1.9 VIEW AUTOSHOW LIST



View AUTOSHOW  
list

Shows all ignition lines used by the device, if an AutoShow has been created.

---

#### 4.1.10 EDIT WAVE FLAMER SETTINGS



Edit WAVE-Flamer  
settings

Here you can edit different settings of the projector. See the corresponding sub chapter.

#### 4.1.11 EDIT DMX SETTINGS



Allows you to change the DMX settings of the projector. See corresponding sub chapter.

#### 4.1.12 SYSTEMTEST

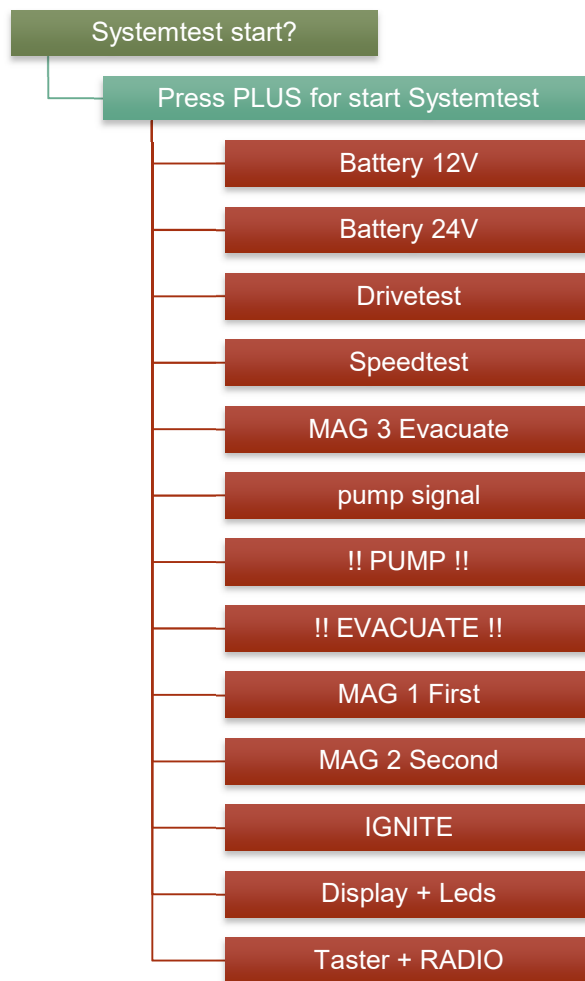
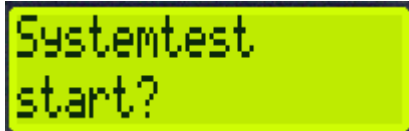

This menu item is used to start different internal system tests. They should only be made after being instructed by qualified personnel.



---

#### 4.1.13 PUMP AND VENT PUMP

A rectangular LCD display with a black border and a light green background. The text is in a black, monospaced font. The first line reads "Pump and Vent" and the second line reads "System ready?&lt;--".

Allows you to pump the system and eject fluid without ignition. It is mainly used to vent the internal system (Especially in combination with the solenoid valves and nozzle). Alternatively, can be used for a test run of the Wave Flamer.

When using **Pump and Ventpump** the Wave Flamer will pump and vent multiple times. Afterwards, the fluid can be ejected manually (automatic 45° leftward sloping of the head).

---

#### 4.1.14 SOFTWARE VERSION

A rectangular LCD display with a black border and a light green background. The text is in a black, monospaced font. The first line reads "Version" and the second line reads "WaveFlamer v1.13".

Shows the current software of the device. A regular checking and updating of the software is highly recommended. You can find further informations for this at the end of this manual.

---

#### 4.1.15 GROUP BOX

A rectangular LCD display with a black border and a light green background. The text is in a black, monospaced font. The first line reads "GroupBOX1: OFF" and the second line reads "GroupBOX2: OFF".

Shows the set Group box numbers. With the Mode/OK button you can switch to the next two Group box number.

This option can only be used for manual ignition signals or for control with the PC-mode (ShowPlayer software) via box- and channelnumber. Automated shows (AutoShow/ ShowCreator) and PC control with an internal TimeCode do not allow for the usage of the Group box numbers set.

## 4.2 WAVE FLAMER SETTINGS

Edit Wave Flamer settings

M-Set: MODUS

M-Set: BOX

M-Set: SEC-KEY

M-Set: FREQUENCY

M-Set: POWER

M-Set: TIMEOUT

M-Set: LOCK

M-Set: SYS

M-Set: Pos 1-15 (Igntime)

M-Set: Pos 16-30 (Igntime)

M-Set: Pos 1-15 (20ms pulse)

M-Set: Pos 16-30 (20ms pulse)

M-Set: CENTER

M-Set: Invert

M-Set: Pos MIN

M-Set: Pos MAX

M-Set: System Restore Default

M-Set: Demo Mode

M-Set: Radio prog

M-Set: GroupBOX

M-Set: Pump

M-Set: Pressure



---

#### 4.2.1 M-SET: MODUS

Allows you to set the device into test-, armed- or sleep-mode.

---

#### 4.2.2 M-SET: BOX

Allows you to set the main box of the device from 1-99.

---

#### 4.2.3 M-SET: SEC-KEY

Allows you to set the Secure-Key of the device (Standard 139). The Secure-Key can be used to encrypt the radio transmission within a systemaddress seperately. Transmitters can only control devices set to the same Secure-Key.

---

#### 4.2.4 M-SET: FREQUENCY

Allows you to change the frequency of the internal radio module (Standard 6, minimum 1, maximum 10).

---

#### 4.2.5 M-SET: POWER

Allows you to change the radio modules power output (Standard 10).

---

#### 4.2.6 M-SET: TIMEOUT

Allows you to set the time, after how many seconds the receiver will the stop the internal synchronization after the transmitter has stopped sending signals (In seconds from 6 to 99seconds, or "infinity", standard 30sec). The longest option of "infinity" is available, meaning that the Wave Flamer will continue the show until the end, regardless of radio troubles.



**A show in infinity-mode can be stopped anytime by a manual signal. However we still recommend using this mode only if there are no expected dangers from the device during any point of the show.**

---

#### 4.2.7 M-SET: LOCK

Allows you to lock the receiver menu. Also allows you to set the code needed to unlock the menu.

---

#### 4.2.8 M-SET: SYS

Allows you to change the systemaddress of the receiver.

---

#### 4.2.9 M-SET: POS 1-15 (IGNTIME)

Allows you to set the opening- or ignition time of short single ignitions (Position 1-15, standard 40ms).

---

#### 4.2.10 M-SET: POS 16-30 (IGNTIME)

Allows you to set the opening- or ignition time of short single ignitions (Position 16-30, standard 340ms).

---

#### 4.2.11 M-SET: POS 1-15 (20MS PULSE)

This value should not be changed (Standard OFF).

---

#### 4.2.12 M-SET: POS 16-30 (20MS PULSE)

This value should not be changed (Standard OFF).

---

#### 4.2.13 M-SET: CENTER

Allows you to correct the middle (Position 8, 0 degrees) a few degrees left or right (Standard 512). This can be useful if the device can't be placed absolutely horizontally.

---

#### 4.2.14 M-SET: INVERT

If this menu item is set to "ON", all positions (see 4.1.2) will be mirrored (15↔1, 14↔2, 13↔3, 12↔4, 11↔5, 10↔6, 9↔7, 8=8).

---

#### 4.2.15 M-SET: POS MIN

Allows you to set from which positions (from 1-15) the device may start sequences. Positions below the set ones, won't be used in sequences.

---

#### 4.2.16 M-SET: POS MAX

Allows you to set up to which positions (from 1-15) the device may start sequences. Positions above the set ones, won't be used in sequences.

---

#### 4.2.17 M-SET: SYSTEM RESTORE DEFAULT

This menu item allows you to reset the device to factory settings, and deletes the show.

---

#### 4.2.18 M-SET: DEMO MODE

Allows you to toggle the demo-mode on or off. In this mode the device will react, however only the head will move, and ignitions be made. Fluid won't be ejected in demo-mode.

---

#### 4.2.19 M-SET: RADIO PROG

Allows you to set whether the device can be programmed via radio (ON). If this option is set to "OFF", the device can't be saved onto the transmitter.

---

#### 4.2.20 M-SET: GROUPBOX

This sub menu allows you to set up to ten different group boxes. The group box is a box number allowing you to control the device with manual ignitions in addition to its regular main box number.

Since all devices with the same box number will ignite at the same time, this allows for easy setting of device groupings for manual ignitions.

#### 4.2.20.1 EXAMPLE



	A	B	C
<b>Main Box</b>	10	11	12
<b>Group Box 1</b>	15	15	15
<b>Group Box 2</b>	16	16	17
<b>Group Box 3</b>	18	17	18

In the example above, every Wave Flamer has its own main box. This is the standard box number of the device, which allows for manual and automatic ignitions.

In addition, group boxes can be assigned, allowing for manual control. This way, ignitions of box 15, will activate all devices at the same time. Box number 16 will only activate device A and B.

22



**Group boxes can only be used for manual control, and can't be used in automated shows.**

#### 4.2.21 M-SET: PUMP

Allows you to change between an internal and external pumping unit. This option is currently only used to differentiate between the X2 Wave Flamer and the X2 Wave Flamer Head. The standard setting for the X2 Wave Flamer is "INSIDE", whereas for the Head it is "OUTSIDE". The standard should not be changed.

#### 4.2.22 M-SET: PRESSURE

Allows you to change the pressure slightly to level slight differences in flame height. You can select between "LOW", "MID" and "HIGH". The current software only allows for the use of "MID", as the other two options are currently unused.

## 4.3 DMX-SETTINGS

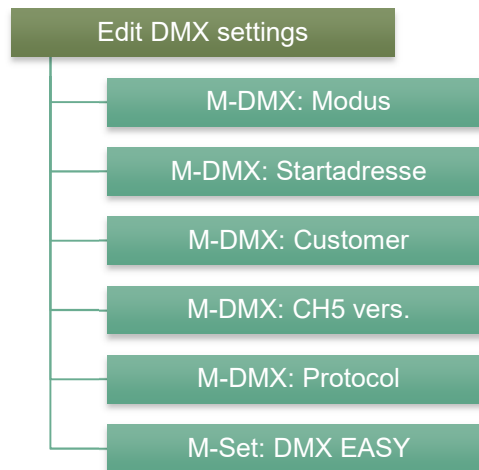

### 4.3.1 M-DMX: MODUS

Allows you to toggle the DMX-mode of the device "ON" or "OFF".

### 4.3.2 M-DMX: STARTADRESSE

Allows you to set the starting address of the first DMX channel from 1 to 507 (Standard 1). The five following channels are always reserved for the different DMX functions.

### 4.3.3 M-DMX: CUSTOMER

Allows you to select between the standard DMX control (Explo) or the special DMX control of the company Pyroemotions (Pyroemotions).

### 4.3.4 M-DMX: CH5 VERS.

Allows you to set which version of the DMX channel 5 calculations should be used.



**The new calculation (new) is the current method, and the one described in this manual.**

### 4.3.5 M-DMX: PROTOCOL

Allows you to set whether you want to use the standard DMX control (DMX 512) or the Easy DMX mode (DMX EASY). A detailed guide of the Easy DMX mode can be found in the description of the control methods.

### 4.3.6 M-SET: DMX EASY

Allows you to set the preferred channel numbers to the DMX addresses of the Easy DMX mode. A detailed guide of the Easy DMX mode can be found in the description of the control methods. The first DMX channel is reserved as a safety channel. The channels 2-16 are standard sequences (see attached list of sequences).



**If the DMX controller used control less than 70 DMX channels, we recommend setting the unused DMX channels to "OFF" (Don't assign sequences or single channels).**

## 5 GENERAL, DEFINITIONS

### 5.1 DEFINITION AUDIENCE SIDE

Across from the usage elements side is the audience side (Back) of the projector. This is the side that should be facing the audience during a show.

All sequences and positions have been created from this viewpoint. The position numbering from 1 to 15, as well as the movement definitions of left, middle and right, are thusly only correct if the device is placed and viewed correctly. The following graphic shows the X2 Wave Flamer from above and should give you an overview of the designation for the positions and movement areas. Further, this has the bonus of having all control lights face away from the audience, not disturbing the viewer while activated.

24

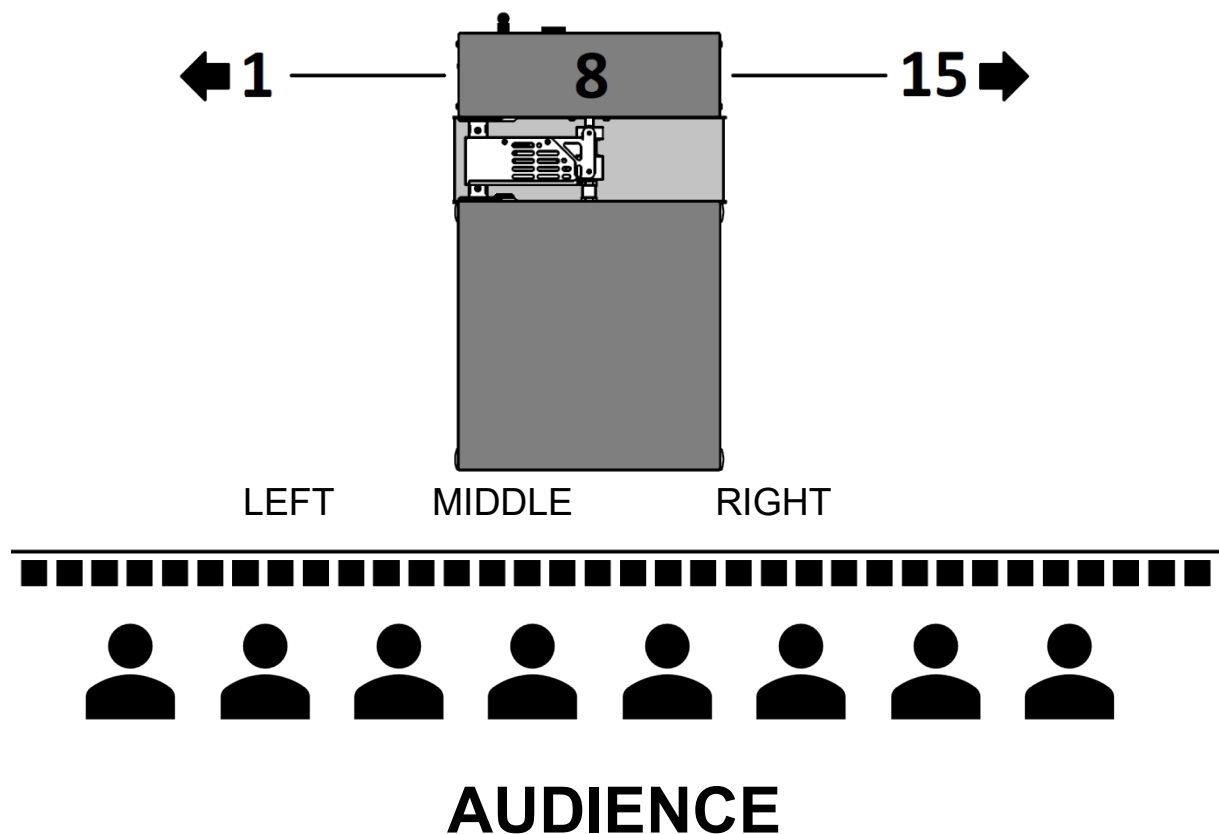



## 5.2 DEFINITION POSITIONS

Contrary to the control via DMX, not considering flame waves, only certain angles can be controlled via radio. Overall, a spectrum of 210° ( $\pm 105^\circ$ ) can be selected. This range has been separated into 15 positions, with a difference of 15° between each for radio control. These 15 positions have been numbered from 1-15, and the middle, vertical position (Position 8) has been defined as 0°. The following graphic shows the single positions as viewed from the audiences side.

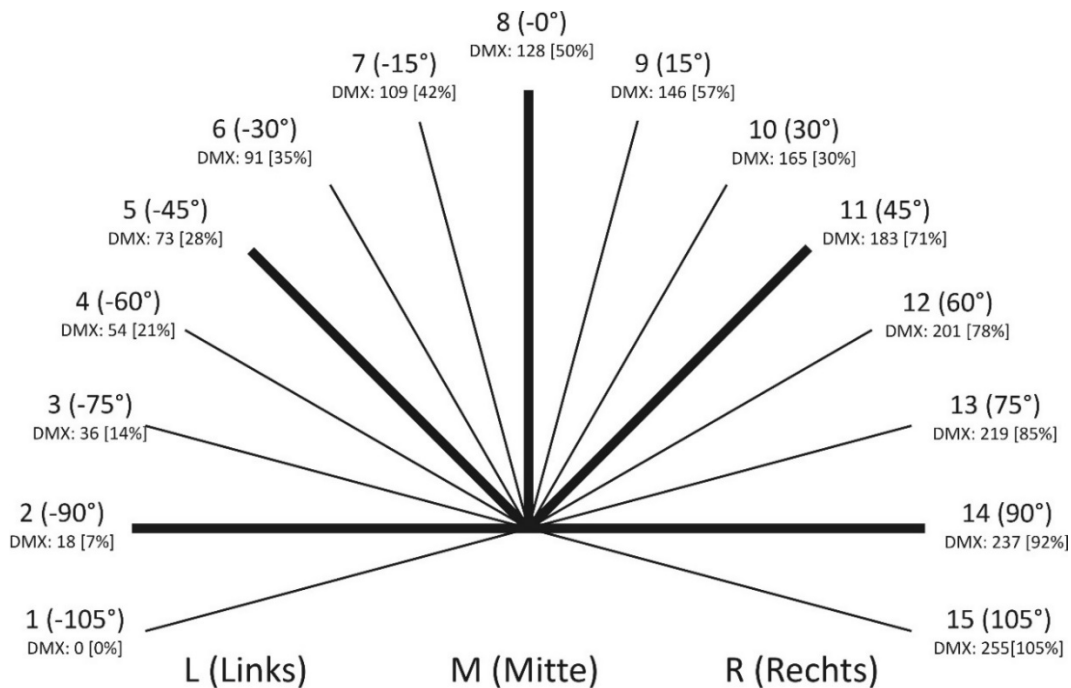

25

## 6 PLANNING AN PREPARING A SHOW

A successful show begins with planning. We recommend giving some thought to these points:

Planning checklist
Is the use of the X2 Wave Flamer allowed at the location?
Can the necessary safety distances be adhered to?
How many X2 Wave Flamers can and do I want to use?
Which flame height do I want and can I use (Selecting the nozzle!)
What fluid do I wish to use?
Optional: Planning an automated show (only for radio control).

Nothing is more frustrating than a X2 Wave Flamer whose fluid or cable has been forgotten in storage. So these points should be checked before driving to the show location:

### Checklist before driving to your show location

Do I have the correct amount of Wave Flamers with me?

Do I have the correct nozzles with me?

Do I have enough liquid fuel with me?

Are the ignition electrodes clean and in the correct position?

Do I need further accessories? (Tripod, socket wrench, connection cables?)

Do I need mechanical angle blockers, and are they mounted already?

Do I have the needed controllers with me and programmed?

Have the devices been checked for function and leak tightness?

Optional: Has the automated show been tested?

Optional: Do I have the needed antennas with me?

If these questions can be answered with YES, you are one step closer to a successful show.



**Devices and automated shows must be tested before their use.**

## 26

### 7 POSITIONING AND PREPARATION AT THE SHOW LOCATION

#### 7.1 POSITIONING OF THE DEVICES

Generally the X2 Wave Flamer must have enough distance to all living beings and objects, so that they may not be harmed or endangered by the use of the projector. The safety distances provided by the manufacturer can be found in the chapter "Safety" of this document. Generally the distances provided by local authorities and safety personnel are to be adhered.

For positioning it is recommended to have the front panel face away from the audiences side. The X2 Wave Flamer must be placed on firm, even ground, or a suitable tripod with a minimum of 50Kg bearing load.

#### 7.2 POWER SUPPLY

Using the provided power cable, the X2 Wave Flamer can be connected to the 100V-240VAC power supply. Please note that every projector has a power consumption of 350W. The power supply should be suitable for the number of devices used. Should you use your selfmade, or store bought power cables, make sure the cable diameter is at least 1,5mm<sup>2</sup>.

With a strong lead acid battery and a sinus inverter the X2 Wave Flamer can also be powered without the need of a grid supply. We recommend using a separate sinus inverter with at least 1000W per X2 Wave Flamer.

## 7.3 PREPARING FOR THE SHOW

Before the show, the following should be checked once more:

Checklist before the Show
Did I vent the system?
Have I made a test run?
Are all safety distances adhered?
Is a CO2 fire extinguisher ready for emergencies?
Can all Wave Flamers be used permanently?
Can I cut the power to the devices immediately in an emergency?
Optional: Do I have refilling fluid ready?
Optional: Are all actors informed?
Optional: Take note of the fire detectors and extinguishers on location.

## 8 CONTROLLING THE X2 WAVE FLAMERS - GENERALS

Generally, the X2 Wave Flamer has been fitted with a radio module which allows for control with an Explo transmitter. Ideally a TX2-70K, which features 10 spare buttons that can be freely programmed.

Via the built in 3 pole XLR connectors, the Wave Flamer can be controlled with a fitting DMX controller.

A benefit of the radio control is the fast execution of the predefined sequences, that can't be done via DMX. This is due to the time needed for the DMX signals to be interpreted by the machine. Furthermore, the device can be easily added into a show and synchronized with other Explo devices.

An advantage of the DMX control however is a much higher resolution of angles that can be used, and the freedom in designing a show this way.

27

### 8.1 ACTIVATION

To activate the device, you must first put the wip switch into its ON position (Labeled "I"). Next you can turn the key switch 90° right, to fully activate the device. If the key switch remains activated, the device will start normally in its last configuration after a temporary power loss. If you do not wish to use this feature, you can turn the key back to its previous setting.



**Expert hint: If you hold the Mode/OK button during startup, the device will start in radio mode. With a held Test/ESC button the DMX mode will be activated.**

### 8.2 SWITCHING OFF

Before switching the device off, it must be disarmed for safety reasons. This is done via radio control once the transmitter is switched to test mode (by sending a disarming signal to all receivers) or via returning the mode channel of your DMX controller to its 0 setting.

After disarming, the minus button of the X2 Wave Flamer can be pressed to completely remove all pressure from the system.

Once the pressure has been released, the device can be switched off by use of the main switch.

## 9 MANUAL CONTROL VIA RADIO

The X2 Wave Flamer features a predefined set of sequences (see **attachment 1 - List of sequences**), which allow for direct use of several sequences via box and channel numbers.

A detailed guide on how to send manual ignition signals can be found in the manual of the X2-series.

### 9.1 PREPARING THE MANUAL IGNITION MODE

In order for the X2 Wave Flamer to be able to receive ignition signals via radio control, the DMX mode must be deactivated. After switching the DMX mode off, a restart of the system is necessary.

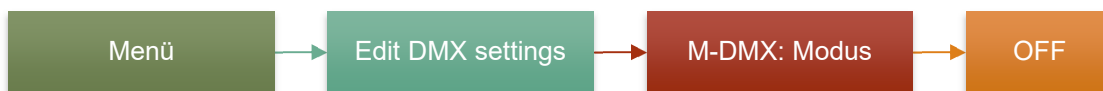

Further, in the GroupBOX menu you can check if the group box numbers needed for the show have been assigned:



28



**In manual ignition mode, the Wave Flamer will accept any ignition command on its assigned Group box number.**

## 10 AUTOMATIC CONTROL VIA RADIO (AUTOSHOW)

In a fully automated show (AutoShow) you can use the predefined ignitions according to the list of sequences (see **Attachment 1 - List of sequences**). Further there is a possibility to change the opening times of single ignitions and sequences.

Programming an automated show can be done either in the free software **AutoShow** or the separately sold software **ShowCreator X2**. We generally recommend the use of the Showcreator, since it shows you an overview of your music, and allows for perfectly timed ignitions, as well as a simulation of the Wave Flamer effects, and a calculation of the approximate fluid usage.

### 10.1 PREPARING THE AUTOMATIC IGNITION MODE (AUTOSHOW)

In order for the X2 Wave Flamer to be able to receive ignition signals via radio control, the DMX mode must be deactivated. After switching the DMX mode off, a restart of the system is necessary.



### 10.2 PREPARING THE SHOWCREATOR SOFTWARE

#### 10.2.1 BOX NUMBER SETTINGS

To activate the simulation of the Wave Flamer and show the fuel consumption, the box numbers of the X2 Wave Flamer must be designated correctly.

Open the menu item **Extras > Settings > Box settings**, and set the number of ignition channels of the X2 Wave Flamer to **Liquid**.

BoxNr	Sys	Info	Anzahl Zündkanäle	Anzahl Boxen
1	50			5
2	50		1	0
3	50		5	0
4	50		20	0
5	50		30	0
6	50		60	0
7	50		70	0
8	50		Liquid	0
9	50		Brenner	0
			WavePlayer	0
			Splittbox	0
			0	0
			70	0



The setting "Burner" is used for gasprojectors with receivers, and can't be used for the X2 Wave Flamer.

After changing the box number to liquid, you can select the correct amount of Wave Flamers used per box number. You can reset the the number of boxes with the button "Reset amount of boxes".

Next, you can set the correct amount. This is mainly used for the correct display of the simulation. In the following example, we will use 5 devices on box number 1, and one device on box number 2.

BoxNr	Sys	Info	Anzahl Zündkanäle	Anzahl Boxen
1	50		Liquid	2
2	50		Liquid	1

### 10.2.2 SIMULATION WINDOW

After selecting the box numbers, you can close or open the simulation window at any time by clicking the checkbox "Simulation" in the lower right corner of the software.

30

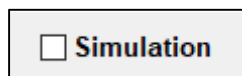

In the simulation window, the previously assigned Wave Flamer boxes will now be shown in their correct amount.

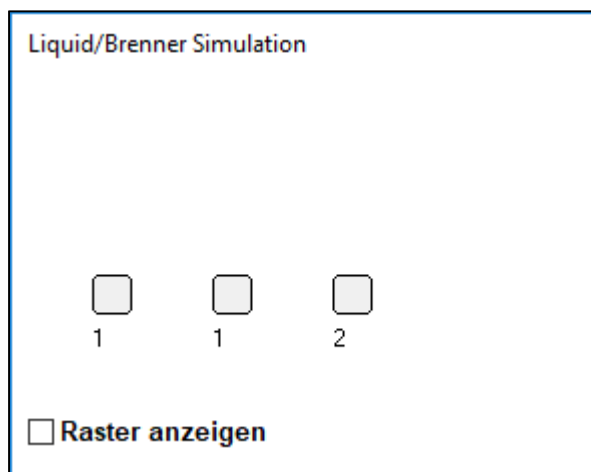

The number below the shown Wave Flamers (grey boxes) is the box number of the device. The Wave Flamers can be moved freely within this window by clicking and dragging them with the left mouse button. An optional grid (Checkbox "Show grid") helps with the positioning.

Should Wave Flamers be inverted for the show (software), or be placed the other way, then you can change this too in the simulation. With a doubleclick into the corresponding devices box, it will be defined as inverted. This is marked by the letter "i" (see right most Wave Flamer in the graphic below).

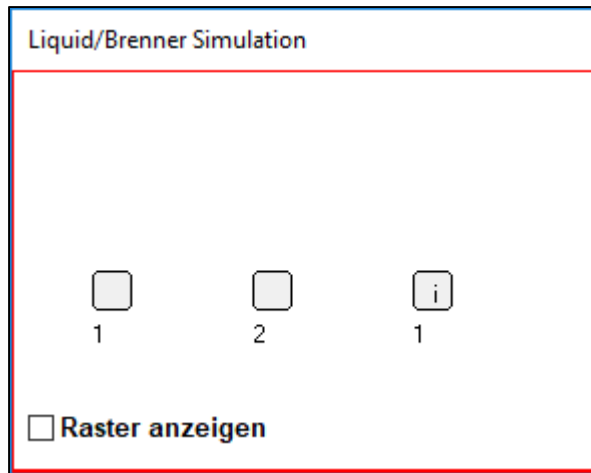



**The inversion of the device won't be transmitted per software, and must be done manually in the devices menu itself.**

If the show is started in the ShowCreator, the flame effects will be displayed synchronized in the simulation window.

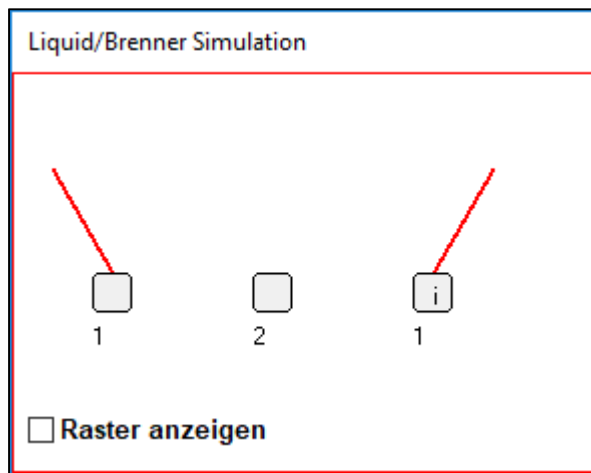

31

### 10.3 SETTING IGNITION CUES

To set ignition cues synchronized to the music, you can control the music file with the buttons "Start", "Pause" and "Stop" (see picture below). Next to it, the current time will be shown.



By clicking the command prompt **Effekt** (see below) an ignition cue can be placed perfectly synchronized while the music is playing. It is empty for now and can be filled with an effect later. It is recommended to first set all ignition cues, and only assign the effects at the end.

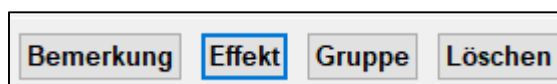



It is recommended to first set all ignition cues in accordance with the music, and only assign the effects at the end.

## 10.4 SELECTING AN EFFECT

Once all ignition cues have been set, they can be filled with effects. Right-click into the empty Box/Channel field of the cue to do so (see the yellow box below).

Box/Nr	Explo	Abstand	Effektbezeichnung
	01:54.17	00:00.69	Effekt
	01:54.86	00:00.14	Effekt

In the new window you can select the preferred box number, as well as the effect you wish to use.

**Auswahl der Box mit Doppelklick** ✕

**Box 1 Liquid**  Box wechseln

Steigzeit  Single Ignition short flame (15°)  
0,11 Sec.

-

Invertieren

63	64	65	66	67	68	69	70							
51	52	53	54	55	56	57	58	59	60	61	62			
41	42	43	44	45	46	47	48	49	50					
31	32	33	34	35	36	37	38	39	40					
16	17	18	19	20	21	22	23	24	25	26	27	28	29	30
1	2	3	4	5	6	7	8	9	10	11	12	13	14	15

The channel numbers 1-70 match the list of sequences (see attachment 1 - List of sequences). A simple click on the channel number allows you to view the effect. A double-click assigns the effect to the cue.

The rise time field has no use for X2 Wave Flamers. This option is used for devices of the old radio system V1 to add a driving time (lead time), which the swivel head will need to reach the wanted angle. With the new radio system X2, this calculation is made automatically.

The settings **Angle 1-15** and the checkbox **Invert** are not in use as of now in the ShowCreator (Beta 44).



## 10.5 GROUP BOXES

The ShowCreator Version 4.12 Beta 40 allows you to define group boxes, which will add a selected effect with one click to all boxes. This makes work easier if many different box numbers are used.

To designate group boxes, open the menu item **Extras > Settings > Group Boxes**. The following window allows you to set new group boxes, or delete them. When creating a group box for Wave Flamers, note that the option **Channels > Fixed** has been selected. The option "Rising" is only used for pyrotechnical ignition receivers, where every channel should only ignite once.

In the example below a group box (Name GB1) has been created, to which the Wave Flamers with box numbers 1 and two have been added.

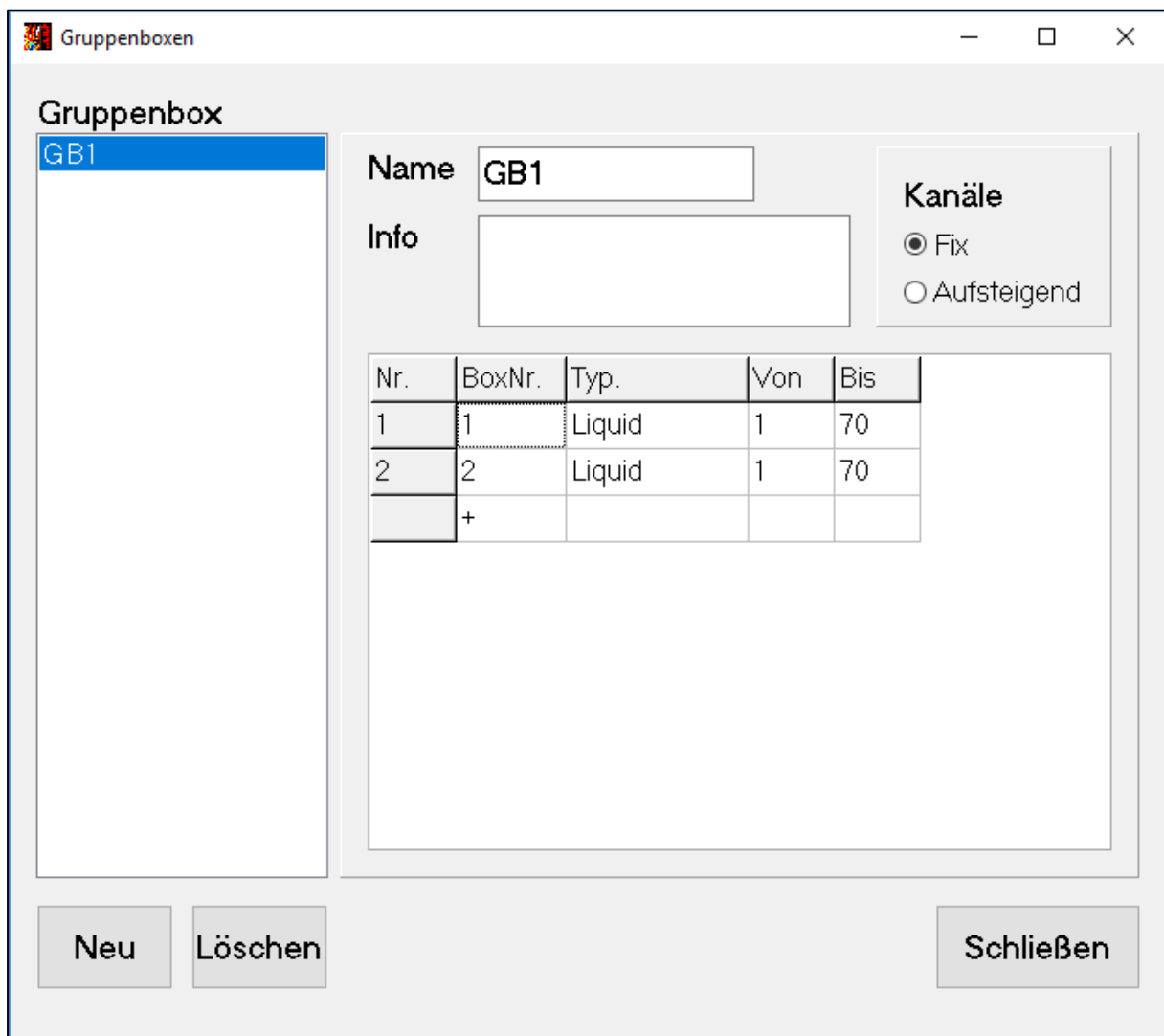

After creating the group box, it can be selected from the right side of the effect window (see following picture). In this example, an effect added to group box GB1 would also be added to box number 1 and box number 2 at the selected ignition time.

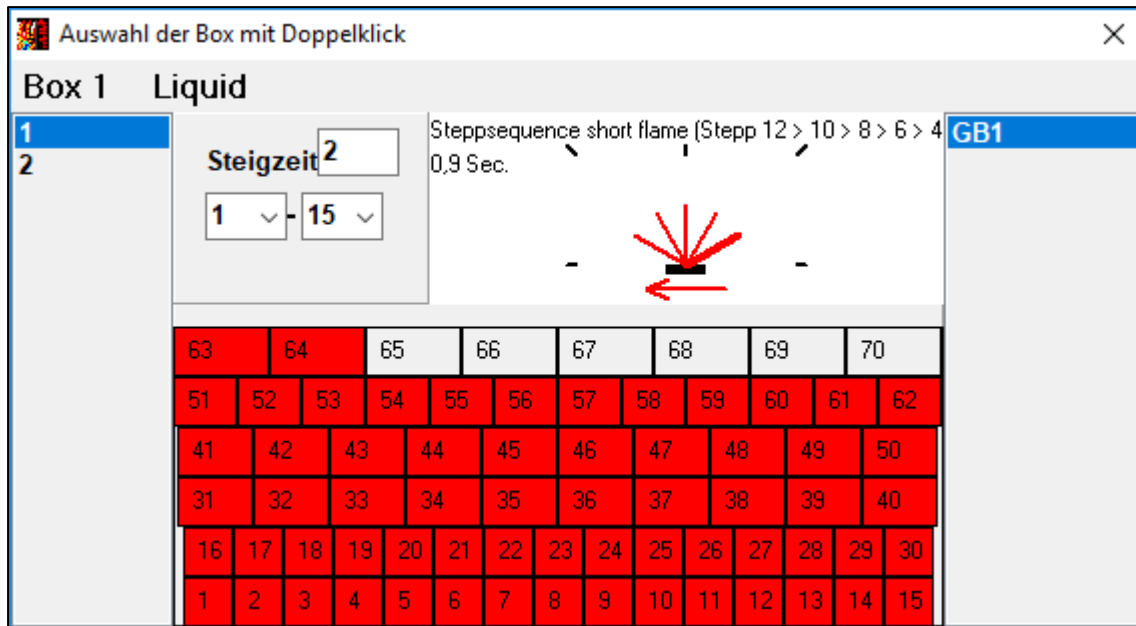

**Most of the time, Scenes are added to Wave Flamer shows, where all devices, regardless of box number, should create the same effect simultaneously. Using a group box can save you lots of valuable programming time.**

# 34

## 10.6 DESIGNATING AND USING GROUPS IN THE SHOWCREATOR

The ShowCreator 4.12 Beta 40 allows for the designation of groups, that can be copied and / or be moved at the same time. This means you don't need to add every sequence or single ignition for every Wave Flamer one at a time.

The function of the group is shown in the following example. Baseline is a show with three X2 Wave Flamers (box 1, 2 and 3). In the following pictures, a part of the show is shown, into which a simultaneous ignition of all three boxes at the same ignition time has been added:

Box/Nr	Explo	Abstand	Zündzeit	Effektbezeichnung
50/1 (2) wave	00:00.02	00:01.82	00:00.02	Wave 01 Start
1/1 (2)	00:01.84	00:00.00	00:01.84	Single Ignition short flame (-105°)
2/1 (3)	00:01.84	00:00.00	00:01.84	Single Ignition short flame (-105°)
3/1	00:01.84	00:10.48	00:01.84	Single Ignition short flame (-105°)
	00:17.00			Ende

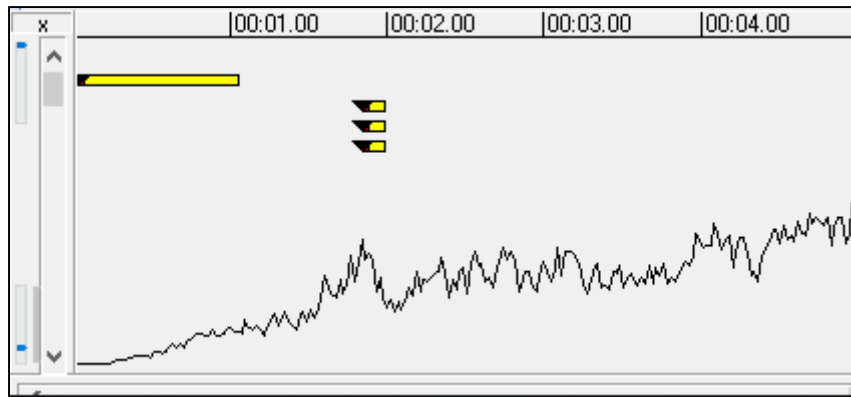

### 10.6.1 CREATING A GROUP

If this simultaneous ignition of the three boxes should be repeated at another spot, every ignition had to be defined anew until recently. The current software allows you to group the three ignitions together, which can then be copied, changed or moved.

The first step is defining a group. Simply click and hold the left mouse button to mark the ignitions you wish to use (see below).

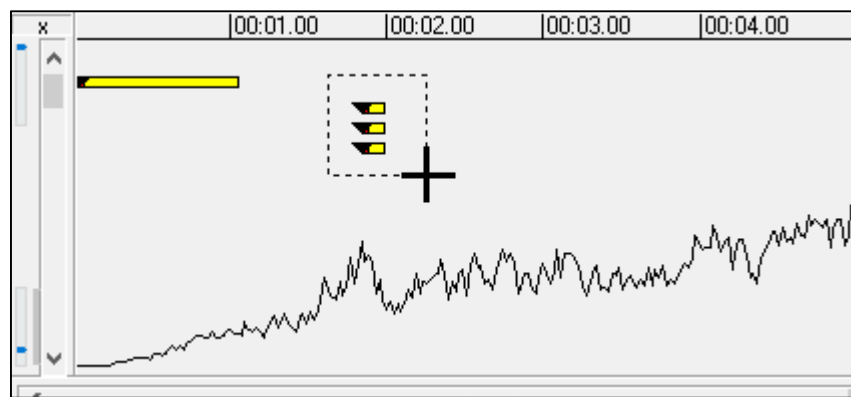

If marked correctly, the selected ignitions will be grouped together. This is shown in the field "Group". The first assigned group is named 1, the second 2, and so forth.

Box/Nr	Explo	Abstand	Zündzeit	Effektbezeichnung	Gruppe
50/1 (2) wave	00:00.02	00:01.82	00:00.02	Wave 01 Start	
1/1 (2)	00:01.84	00:00.00	00:01.84	Single Ignition short flame (-105°)	1
2/1 (3)	00:01.84	00:00.00	00:01.84	Single Ignition short flame (-105°)	1
3/1	00:01.84	00:10.48	00:01.84	Single Ignition short flame (-105°)	1
	00:17.00			Ende	

## 10.6.2 MOVING A GROUP

### 10.6.2.1 Moving via mouse click

To move a group, it can be dragged and moved to any other point in the show, clicking and holding it with the left mouse button. The ignition time will be adjusted automatically.

### 10.6.2.2 Moving to a certain ignition time

You can also redefine the exact ignition time for the whole group. Right click into one of the ignitions of the group, or the group field. The following window appears:

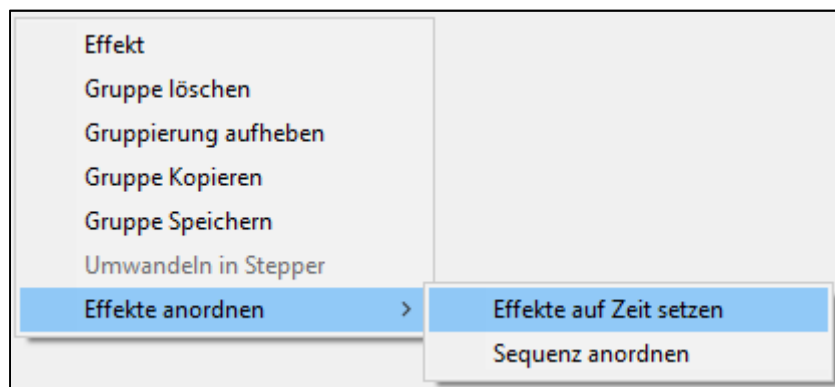

At "Sort Effects" you can select the option "Set effects to time". In the now opening window you can set the preferred ignition time:

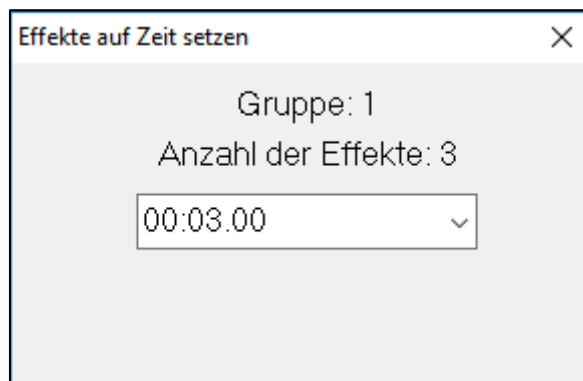

**When using the option "Set effects to time" all ignitions of the group will be set to the same time. Distances between ignitions won't be considered.**

### 10.6.2.3 MOVING A SEQUENCE TO A CERTAIN IGNITION TIME

A third option, is setting the group as a sequence (including time intervals) to a certain starting point. Here you can select the option "Sort sequence" under the menu "Sort effects". In the newly opened window, different changes can be made to the sequence:

The screenshot shows a dialog box titled "Sequenz anordnen" with a close button (X) in the top right corner. The dialog contains the following elements:

- Text: "Gruppe: 1"
- Text: "Anzahl der Effekte: 3"
- Text input field: "00:03.00" with a dropdown arrow on the right.
- Text: "Sequenz Dauer" above a text input field containing "2,00".
- Text: "Intervall" above a text input field containing "1".
- Text: "<->" between the "Sequenz Dauer" and "Intervall" input fields.
- Text: "Anordnung" above a container with two radio button options:
  - "Erste -> Letzte"
  - "Letzte -> Erste"
- Buttons: "Anordnen" and "Schließen" at the bottom.

37

Sort sequences	
<b>Ignition time</b>	Allows you to set the ignition time of the first ignition.
<b>Sequence duration</b>	Allows you to set the whole duration of the sequence. The software will calculate the interval automatically from this.
<b>Interval</b>	Allows you to set the interval between the single ignitions. The software will calculate the duration automatically from this.
<b>First -&gt; Last</b>	Will set the lowest box number as the first ignition, and the highest as the last.
<b>Last -&gt; First</b>	Will set the highest box number as the first ignition, and the lowest as the last.

If all settings have been made, the sequence can be moved with the button "Sort".

---

### 10.6.3 CANCELLING A GROUP

To cancel a group, right click one of the ignitions of the group, or click into the group field of the cue. The following window appears:

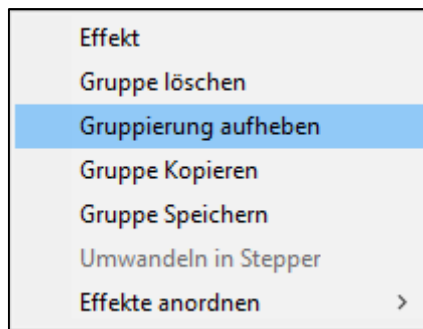

Using the command "Lift group", the selected group will be cancelled.

---

### 10.6.4 DELETING A GROUP

To delete a group, right click one of the ignitions of the group, or click into the group field of the cue. The following window appears:

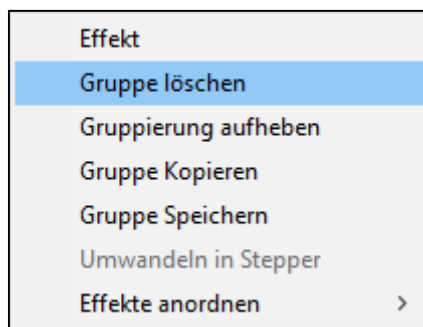

Using the command "Delete group", the selected group will be deleted.

---

### 10.6.5 COPYING A GROUP

To copy a group, right click one of the ignitions of the group, or click into the group field of the cue. The following window appears:

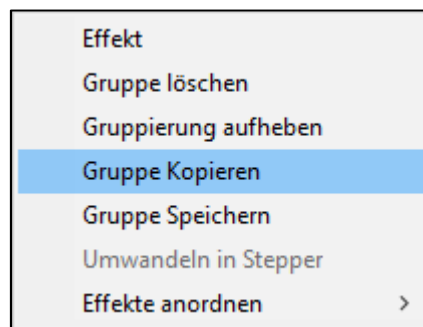

Using the command "Copy group" an exact copy will be made. This newly created group can be moved freely.

## 10.6.6 SAVING A GROUP

To save a group, right click one of the ignitions of the group, or click into the group field of the cue. The following window appears:

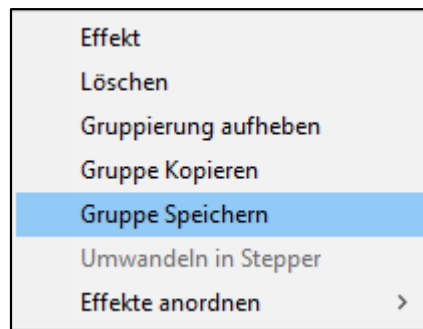

Using the command "Save group", the group can be named and saved. The saved group can be added to any preferred time by pressing the button "Group" and adding it:

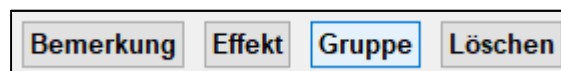

## 10.7 SETTING AN OPENING TIME

For some single ignitions and sequences, and opening time can be set in the ShowCreator, or the AutoShow. The ignitions/sequences that can be changed are marked in red in **Attachment 1 - List of sequences**.

39

### 10.7.1 SETTING AN OPENING TIME IN THE SHOWCREATOR:

In the ShowCreator the opening time of every sequence can be changed. To do so enter the preferred time into the effect time column of the ignition:



The screenshot shows the ShowCreator interface with a menu bar (Datei, Bearbeiten, Ansicht, Extras, Hilfe) and a toolbar. The main display area shows a table of ignition data. The 'Zeit' column is set to 00:00.02. The 'Effektzeit' column is highlighted in red for several rows, indicating they can be changed. The 'Effekt' column is highlighted in green for the 'Ende' row.

Box/Nr	Explo	Abstand	Zündzeit	Effektbezeichnung	Effektzeit
50/1 (2)	00:00.02	00:02.96	00:00.00	Wave 01 Start	1
1/1 (2)	00:02.98	00:00.00	00:02.98	Single Ignition short flame (-105°)	1
1/33 (2)	00:02.98	00:00.00	00:00.98	Stepsequence short flame (Stepp 5 > 8 > 1 2)	2,5
1/36 (2)	00:02.98	00:00.00	00:00.98	Stepsequence short flame (Stepp 10 > 6)	2,5
4/3	00:02.98	00:14.02	00:02.98	Single Ignition short flame (-75°)	0,33
	00:17.00			Ende	



Only the opening times of ignitions and sequences marked in red can be changed, as seen in Attachment 1 - List of sequences.

## 10.7.2 CHECKING AND CORRECTING OPENING TIMES IN THE AUTOSHOW

The adjustable opening times are subject to the possible settings of **Attachment 4 - Opening times**. If the selected opening time can be used, can be checked easily after importing the show into the AutoShow software. For this, save the show, and use the import function **File > Import Show** of the AutoShow.

After the import, the used Wave Flamer boxes have to be designated as Liquid burners. This is done either via the options field, or **Settings > Boxes**. After defining the boxes as liquid projectors, all effect times that have been assigned in the ShowCreator, will be automatically changed to the next possible opening time.

Lfd.Nr.	Box/Kanal	Zündzeit	Abstand	Seq.	Option	Gruppe	Effektzeit
1	50/1	000:00,00	0,98				1,00
2	1/36	000:00,98	0,00		Liquid	t	3,39
3	1/33	000:00,98	2,00		Liquid	o	2,29
4	4/3	000:02,98	0,00		Liquid	l	0,37
5	1/1	000:02,98	14,02		Liquid	s	1,07
6		000:17,00	0,00				0,00
Neue Zeile					0		

Die ÖffnungsTimeen können mit den Gruppenbuchstaben (Spalte **Gruppe**)

40

## 10.7.3 CHECKING FLUID USAGE IN THE AUTOSHOW

If the Wave Flamers have been designated as such in the AutoShow, the approximate fuel consumption (in Liters) can be viewed using the button "Show Boxes".

Boxen anzeigen

In the newly opened window, every Wave Flamer Box number will show its total consumption during the show (Column "Consumption/Liter").



	Box-Nr.	Kanäle	Typ	Verbrauch/Liter
1	Box 1	1	Liquid	0,3



## 10.8 CALCULATING THE DRIVE TIME

If a music synchronous flame show is to be created, the drive time between the single ignitions must be calculated. With the V1 version (unidirectional radio control) the drive time to the next position is entered as the rise time. With the X2 version (bidirectional radio control) the device will automatically move to the next ignitions angle and wait for the time to fire. Between ignition a larger amount of time must be chosen as the drive time.

Angle	Drive time
$\pm 105^\circ$	170ms
$\pm 90^\circ$	150ms
$\pm 75^\circ$	130ms
$\pm 60^\circ$	110ms
$\pm 45^\circ$	90ms
$\pm 30^\circ$	70ms
$\pm 15^\circ$	50ms
$\pm 0^\circ$	0ms

	<b>Even though calculating the drive time for the X2 series is done automatically, it is still necessary to leave enough distance between single ignitions (minimum drive time + opening time).</b>
	<b>If the Wave Flamer can't end an effect before the start of the next ignition, it will still make it, and simply move all following ignitions back. This can lead to a nonsynchronous show in conjunction with the music.</b>

41

## 10.9 TRANSFERRING THE SHOW TO YOUR DEVICES

A detailed guide on how to transfer a show to your transmitters and receivers can be found in the X2-series manual. Note: A show created in the ShowCreator must be transferred to the transmitter via the **AutoShow X2**.

The AutoShow allows you to have a quick look over the ignition cues and their opening times for the Wave Flamer sequences, as well as changing them if needed.

## 11 CONTROL VIA DMX 512

The X2 Wave Flamer can be controlled via DMX 512 as a standard feature. This is done with 6 DMX channels. A simplified version of the DMX control (the Easy DMX mode) uses only 2 channels (ignition variants and safety channel). This chapter describes the standard DMX control. A guide for the Easy DMX mode can be found in the next part of this manual.

## 11.1 PREPARING THE DMX-512-MODE

Check the settings for the DMX starting address. This is the address of the first channel used:



To activate the DMX 512 mode, you must select the DMX 512 setting in the Protocol menu:

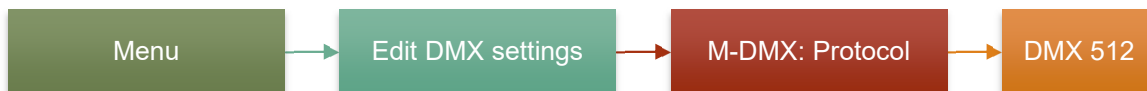

Next, DMX control must be activated:

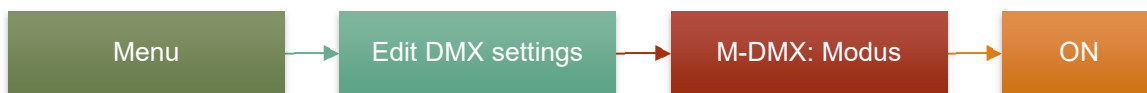

## 11.2 DMX-CHANNELS

The following 6 DMX channels are used to control the X2 Wave Flamer in DMX 512 mode. Since the full spectrum of the channels is used (0-255), the Master switch of the DMX controller should be set to 100%.

DMX channels (DMX 512)		Example DMX value
<b>Channel 1 (Starting address + 0)</b>	Angle	128 – Mid position (0°)
<b>Channel 2 (Starting address + 1)</b>	Speed	0 – maximum speed
<b>Channel 3 (Starting address + 2)</b>	Ignition	0 – no ignition 255 – Ignition
<b>Channel 4 (Starting address + 3)</b>	Opening time	0 – Standard value
<b>Channel 5 (Starting address + 4)</b>	Programm	
<b>Channel 6 (Starting address + 5)</b>	Mode	0 – Test-mode 128 – Armed-mode 255 – Test-mode

---

### 11.2.1 CHANNEL 1: ANGLE (STARTING ADDRESS)

The angle is the first channel (=Starting address). It designates to which angle the head of the Wave Flamer will move to. These angles can be set freely from -105° to +105° (DMX values 0 to 255).

Since the DMX value itself is a whole number (without any decimal places), some angles need to use a rounded value.

The calculated value for an angle of 0° is 127.5 (rounded up to 128). This allows the use of the following formula to calculate the other angles  $\alpha$  (in degrees) (The prefix is to be taken into account):

$$\text{DMX value} = 127,5 + (\alpha \cdot 1,2143)$$

To convert a DMX value into percent, use the following formula:

$$\% \text{ value} = \text{DMX value} \cdot (100/255)$$

Below you can find some examples for the DMX value of certain angles.

Channel	Angle	DMX	DMX (%)
1	-105°	0	0%
2	-90°	18	7%
3	-75°	36	14%
4	-60°	54	21%
5	-45°	73	28%
6	-30°	91	35%
7	-15°	109	42%
8	0°	128	50%
9	15°	146	57%
10	30°	165	64%
11	45°	183	71%
12	60°	201	78%
13	75°	219	85%
14	90°	237	92%
15	105°	255	100%

---

### 11.2.2 CHANNEL 2: SPEED (STARTING ADDRESS +1)

The second channel (Starting address +1) defines the speed of the projector. It can be set with a DMX value of 1 to 255 (Stop to full speed). DMX value 0 is special and also designates full speed.

Speed is bound to time, and not to strength. This leads to a better synchronization of the individual devices. This setting is exempt from "Fading", since a synchronization can be measured only from a distance of 8-9 DMX values (channel 1).

If the Wave Flamer is supposed to fade, a DMX value of 0 or 255 must be set.

	Speed		
<b>DMX-value</b>	0	1 to 254	255
<b>Speed</b>	Maximum	Raising the speed	Maximum

Example for a steady Wave movement	
<b>1</b>	Drive to starting point. (CH1 Angle = 0, CH2 Speed = 255, CH3 Ignite = 0)
<b>2</b>	Once the starting point has been reached, select CH2 Speed. (Ch1 Angle = 0, CH2 Speed = 50, CH3 Ignite = 0)
<b>3</b>	Set ending point and ignite. (CH1 Angle = 255, CH2 Speed = 50, CH3 Ignite = 255)
<b>4</b>	The swivel head will now move steadily to the ending point and ignites.

### 11.2.3 CHANNEL 3: IGNITION (STARTING ADDRESS +2)

The third channel (Starting address +2) initialises the ignition. If the value of 253 is overstepped, the device will ignite. The DMX value of this channel must fall below 254, before a new ignition with the values 254 and 255 can be made.

44

	Ignition	
<b>DMX-value</b>	0 to 253	254 and 255
<b>Ignition</b>	Projector won't ignite	Projector ignites

### 11.2.4 CHANNEL 4: OPENING TIME (STARTING ADDRESS +3)

The fourth channel (Starting address +3) designate the opening time for ignitions. It can be set in steps of 10ms, up to 2540ms (2,54s) in total (DMX value 0 to 254). DMX value 255 allows for a continuous ignition. This ignition ends if the value drops below 254, at the latest however after 2,5 seconds. DMX value 0 is special and will also do a continuous ignition. This means that the effect will be active, for as long as channel 3 is, however 8 seconds at most.

The following formula can be used for the opening time [ms]:

$$\text{DMX value} = t / 10$$

	Opening time						
<b>DMX-value</b>	0	1	2	3	...	254	255
<b>Opening time</b>	Continuous ignition	10ms	20ms	30ms	...	2540ms	Continuous ignition

### 11.2.5 CHANNEL 5: PROGRAMM (STARTING ADDRESS +4)

The fifth channel (Starting address +4) allows for ignition of one of the predefined sequences. The percentage value is the ignition channel from the list of sequences (see attachment - List of sequences). The values 0 to 2 are unused, so the first sequence (ignition cue 1) starts at DMX value 3 to 5.

The following formula can be used for the DMX value:

$$\text{DMX value} = 2 + \text{Channel number} \cdot (255/100)$$

The following formula can be used for the % value:

$$\% \text{ value} = \text{Channel number}$$

	Programm / Ignition channel						
<b>DMX-value</b>	0 to 2	3 to 5	6 to 7	8 to 10	11 to 12		226
<b>% value</b>	0%	1%	2%	3%	4%	...	88%
<b>Ignition channel</b>	N/A	1	2	3	4		88



**Working with percentages instead of fixed DMX values is much easier and thus recommended.**

### 11.2.6 CHANNEL 6: MODE (STARTING ADDRESS +5)

The sixth DMX channel is the usage mode. Here you can switch the projector into armed mode, with DMX value 50-200. The other DMX values designate test mode. Note that you can only ignite in armed mode.

	Mode		
<b>DMX-value</b>	0 to 49	50 to 200	201 to 255
<b>% value</b>	0%	50%	100%
<b>Mode</b>	Test mode	Armed mode	Test mode



**When switched armed, pressure will start to build in teh Wave Flamer. This first procedure will take about 20 seconds, during which the device won't react to ignition commands.**

## 11.3 IGNITING VIA DMX

In DMX mode, the projector can be ignited the following way:

Igniting via DMX	
1	Set angles to 0° due to safety reasons. (CH1 = 128)
2	Arm device. (CH6 = 50 to 200)
3	Set opening time of single ignition or sequence. (CH4 or CH5)
4	Set angle. (CH1)
5	Activate ignition. (CH3 = 254 or 255)



**Using the newest DMX version, sequences and ignitions can be activated simultaneously. With older versions of the DMX chip, the sequence must be selected first, and after 40ms an ignition can be made. Newer DMX chips are available on request.**

## 12 CONTROL VIA EASY-DMX

The Easy DMX mode is a simplified version of the normal DMX control, using only two channels (ignition variants and safety channel), to ignite predefined commands. This mode is meant for smaller shows, where you can make different sequences via the flash buttons of your DMX controller. The selectable ignition variants can be found in **attachment 1 - List of sequences**. The first DMX channel is reserved as a safety channel. Channels 2-16 are fitted with standard sequences (see attachment - List of sequences).

### 12.1 PREPARING THE EASY-DMX-MODE

Check the settings of the DMX starting address. This is the address of the first channel used:



In the DMX EASY menu you can change the DMX channel numbers used for single ignitions or sequences:



To activate Easy DMX mode, select the option for it in the menu:



Next you must activate the DMX control:



## 12.2 DMX-CHANNELS

The following DMX channels are used to control the X2 Wave Flamer in Easy DMX mode:

DMX-channels	
Channel 1 (Starting address + 0)	Mode
Channel 2-70 (according to Wave Flamer settings)	Single ignition or sequence

### 12.2.1 CHANNEL 1: MODE (STARTING ADDRESS)

The first DMX channel is the usage mode. Here you can set the whether the device should be armed with a DMX value of 50-200. The other values designate the test mode. Note that you can only ignite in armed mode.

	Mode		
DMX value	0 to 49	50 to 200	201 to 255
Mode	Test mode	Armed mode	Test mode



**When switched armed, pressure will start to build in the Wave Flamer. This first procedure will take about 20 seconds, during which the device won't react to ignition commands.**

47

### 12.2.2 CHANNEL 2-70: SINGLE IGNITION / SEQUENCE

DMX channels 2-70 are used after turning the device armed via channel 1, to make single ignitions or sequences. As soon as a DMX channel is set 255, the chosen channel number from the list of sequences will ignite. After ignition, the DMX channel must be reset to 0 before the next ignition. You can only ignite one sequence at a time. To ignite the different variants, we recommend the usage of the flash buttons of your DMX controller.

	Ignition variants (DMX channels 2-70)		
DMX value	0	1-254	255
Mode	Reset (after ignition)	No function	Ignition



**Usually only DMX channels 2-16 have predefined sequences. Further ignitions must be assigned to an individual DMX channel on the Wave Flamer.**

## 13 SAFETY

The X2 Wave Flamer features multiple safety features, meant to protect the device, and allow the user to make certain preparations to prevent damages to persons and objects. Furthermore, the user can prevent risks by adhering to the guidelines mentioned in this manual. Under any circumstances, you should adhere to the safety notes below



### 13.1 ANGLE BLOCKERS

In the year 2018, optionally available angle blockers (mechanical) have been developed, which feature another fail safe next to the software block, giving a 100% guaranteed possibility to prevent certain angles being driven to. These angle blockers are available anytime as a retrofit.



48

The angle block is mounted to either side of the swivel head. A sturdy metal pin can be moved freely to every angle. The X2 Wave Flamer automatically detects the position of the block, and will save it in its software. It is still recommended however, to still manually enter the preferred angles beforehand in the device's menu.

	<p><b>To use the angle blockers, the firmware version 1.56 (or higher) must be installed. If used in conjunction with older firmware, it may lead to damages of the device.</b></p>
	<p><b>The preferred angles should already be locked before fitting the angle blockers to the device.</b></p>
	<p><b>After switching the device on, the position of the metal pin may not be altered, since the device won't note the new position of the block, which will lead to possible damages of the device.</b></p>



## 13.2 SAFETY FEATURES

### 13.2.1 DOUBLE SOLENOID VALVE

The projector has been fitted with two solenoid valves in series. Next to the basically necessary flame valve, a second safety valve has been installed. Without an electrical ignition, these valves cannot open.

### 13.2.2 WATCHDOG-TIMER

An internal watchdog-time constantly checks the function of the processor. Should it be jammed during any ignition routine or similar, a safety interruption of the device will occur, before a reset.

### 13.2.3 MECHANICAL BLOCK

A mechanical block in both movement directions prevents the device from driving to any angle above 120° in both directions.

### 13.2.4 AUTOMATIC SAFETY CHECKS

Automatic safety checks after startup and during usage, check the device for any errors. For example, it will check whether the head is blocked (drivetest) or if the system has a leak.

### 13.2.5 DEACTIVATING THE OUTER ANGLES

The X2 Wave Flamer allows single angles to be blocked before a show, so that these can't be accessed. This can already prevent certain risks before the show, by protecting objects placed in these angles around the device.

### 13.2.6 ARMING THE DEVICE

The device can be turned armed by radio. Therefore it isn't necessary for persons to linger in the closer vicinity of the device, to arm it for use.

Only after this occurs, the pressure needed for usage will be built. This is constantly monitored.

### 13.2.7 POWER OUTAGE

In case of a power outage, the device will interrupt running sequences and the show. After switching it back on again, it will do the usual startup, as long as the key switch was in the ON position. It will start in the previous mode, meaning that a device that was turned armed before the power outage, will also start up in armed mode again.

## 13.3 SAFETY RECOMMENDATION

The following safety recommendations are not compulsory, contrary to the previous ones, but should still be adhered to if possible

### 13.3.1 EMERGENCY SHUT OFF

We generally recommend to use the devices with 230VAC mains voltage, and add an emergency shut off switch into the supply line, to switch them off at any time.

Optionally, a DMX switchbox, which controls the 230VAC power line, can be used as a DMX capable emergency shut off.

### 13.3.2 DRIP PAN

If the device is placed on flammable ground, or the ground is to be protected (eg. stage floorings, ice rings), we recommend using a drip pan, placed underneath the device. This pan should catch any fluids that may leak from the system.

The pan space should be at least 70 x 50cm with a depth of 5cm.

### 13.3.3 INTERRUPTING AN AUTOSHOW

To interrupt an AutoShow, the Wave Flamer must receive a "Pause", "Disarm" or "Test" signal. During a predefined sequence, an incoming signal will be received, but the current sequence will be finished. To guarantee a stop, a test signal should be sent until the device has no longer ignite, or the timeout be set accordingly.

## 13.4 SAFETY HINTS

The device may only be used if it is in a proper state and well maintained. Defective devices must be checked and repaired by the manufacturer, or other authorized person. Under no circumstances may defective devices be used.

After longer storage, the Wave Flamers should be checked for function and leak tightness before usage.

The devices are to be placed atop firm ground. It should be placed horizontally on the floor, and be protected against tipping. If a tripod is used, it must be proofed against tipping.

Should any flammable materials be close to the flame direction, we recommend checking the safety distances with the local authorities and fire department.

After turning the device on, no persons may linger in the vicinity of it. All persons taking part in the show (Helpers, actors,...) are to be informed about the safety distances and basic functions of the device.

During the show, it is possible that small amounts of unmisted fluid fall to the ground. These evaporate normally and should pose no threat.

The person in charge of the devices control must have a clear sight of them at any time. Ideally via a direct line of sight, alternatively however via cameras. This person is in charge of making sure the safety distances are adhered to at any time during the show, and be able to interrupt it if needed.

If controlled via DMX, we recommend the use of an own DMX universe for the Wave Flamers (separating Light and effect devices).

As a preventive measure, a CO2 fire extinguisher and extinguishing blanket should be on hand. While filling the devices with liquid fuels, be very careful. Keep the fuel from heat, hot surfaces, sparks or open flames and other sources of ignition. Don't smoke!

## 13.5 RECOMMENDED SAFETY DISTANCES

The recommended safety distances can be found on the sticker placed on top of the device.

### 13.5.1 FRONTAL VIEW

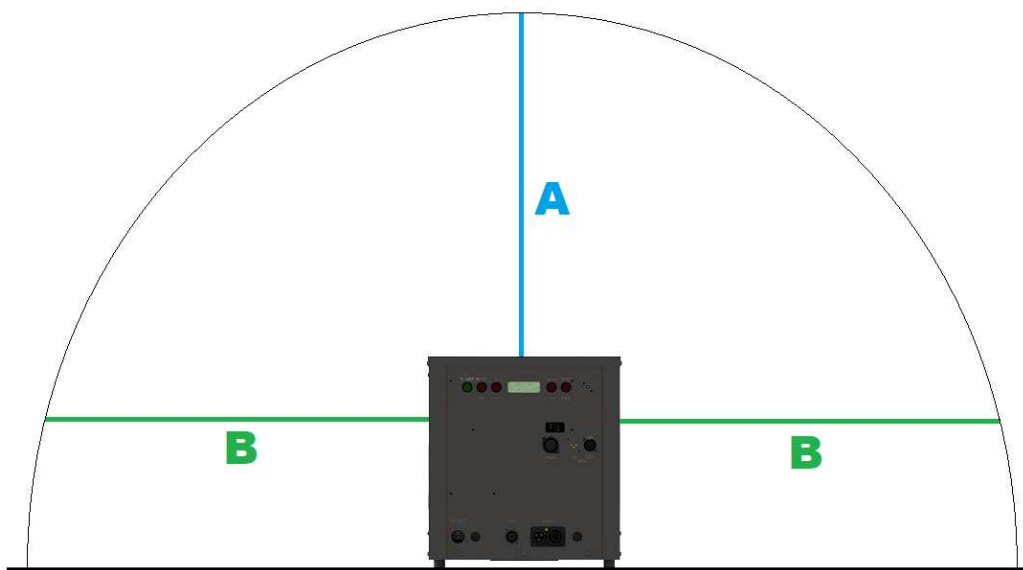

### 13.5.2 TOP VIEW

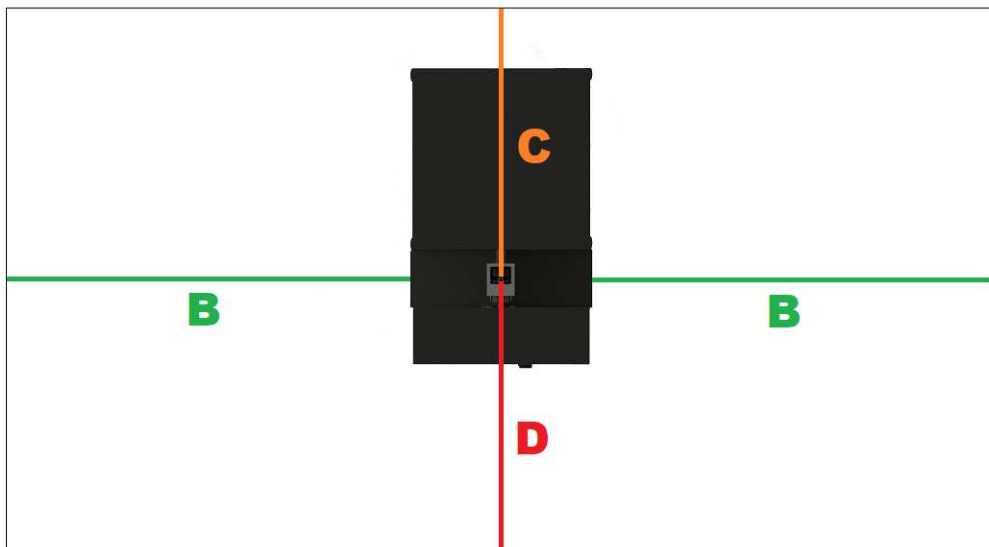

Direction	10m-nozzle	5m-nozzle
A (Roof)	15 m (49,2 ft) *	7 m (23 ft) *
B (To the sides)	14 m (45,9 ft) *	6 m (19,7 ft) *
C = D (Front and back)	3,5 m (11,5 ft) *	2,5 m (8,2 ft) *

52

## 14 STORAGE AND MAINTENANCE

The X2 Wave Flamers surfaces should be cleaned after every show. A normal cleaning cloth and grain alcohol can be used to clean all outer components until no dirt is visible.

If soot settles on the ignition electrodes, they can be cleaned carefully using an old toothbrush. The cables of the electrodes should be checked periodically for any obvious damages.

If stored for a longer duration (> 1 month) the Wave Flamer should be used for a moment, to lubricate the inner system and prevent the pumps from drying out, as well as preventing parts from corroding.



**The X2 Wave Flamer may never be stored will pressurized or in armed mode. Due to safety reasons, we recommend storage with 1L of fluid in the canister, which should prevent an unwanted and harmful pressurizing of the pumps without fluid.**

## 15 TECHNICAL DATA



X2 Wave Flamer	
Measurements	560x335x365mm
Weight	27kg (empty Tank)
Power supply	100VAC-230VAC / 350W
Casing	Stainless steel
Fuel	Isopropylalcohol, Bio-Ethanol, ISOPAR™ / We recommend adding 2cl castor oil per 10L fluid
Radio range	800m
Swivel radius	-105° to 105°
Effect height	10m (optional 5m nozzle available)

## 16 ACCESSORIES (AVAILABLE SEPARATELY)

Optional accessories for the X2 Wave Flamer	
Power connection cable	To lead power through to the next device. Available in all lengths.
Tripod	Tripod for the X2 Wave Flamer. Diameter 35mm / 50kg load bearing.
5m nozzle	Nozzle for reduced flame height (4-5m).
Flight-Case	Flight Case for safe transportation of the Wave Flamers.
Dolly for Flight-Case	Dolly for up to three Flight-Cases (stacked).
Emergency shut off	Emergency shut off switch for immediate interruption of the power supply.
Tool to switch nozzles	Tool to easily change the nozzles of the Wave Flamer. 14mm socket nut long.
Bootloader cable	Programming cable to update the devices firmware.
Rain protection	Protective cover to protect the front panel from water.
Angle blockers	Mechanical angle blockers for the X2 Wave Flamer.

53

## 17 INFORMATIONS FOR USEABLE FLUIDS

	<b>To lubricate the system, we recommend adding 10-20mL castor oil per 10L canister.</b>
	<b>Recommended fluids are: Bioethanol 99%, Isopropanol 99% (IPA), ISOPAR (G, H, L, M)</b>
	<b>If non recommended fluids are used (especially coloured fluids), damages to the system may occur, leading to a voiding of the guarantee.</b>

## 18 SOFTWARE UPDATES

Software updates can be found on the devices corresponding site on our homepage:

<http://www.explo.at/>



### Steps to make a software update

1	<p>Download and install the bootloader software (Or the AutoShow software of the X2 series) and the drivers for the bootloader cable. The needed files can be found at:</p> <p><a href="https://www.explo.at/en/software/gerate-programmierung/bootloader-software.html">https://www.explo.at/en/software/gerate-programmierung/bootloader-software.html</a></p> <p>The driver differentiates between 32-bit (Installer x86) and 64-bit (Installer x64) Windows system architecture. The used type of Windows architecture can found at "System".</p>
2	<p>Download the update file from the product page. The download link can be found at the download header at the bottom of the product page for the Wave Flamer:</p> <p><a href="https://www.explo.at/en/effektgeraete/liquid/x2-Wave Flamer-1.html">https://www.explo.at/en/effektgeraete/liquid/x2-Wave Flamer-1.html</a></p> <p>The update files differ between the radio versions V1 (unidirectional), V2 (older bidirectional) and X2 (newer bidirectional), as well as the processor type 256 and 128.</p> <p>The processor type 256 is marked by the three red status LEDs (ARMED) on the front panel. If these are there, version 256 is used.</p>
3	<p>Select the correct COM interface in the bootloader software. The COM interface can be found in the Windows device manager, at "Connections (COM &amp; LPT)". The correct COM interface is marked as "Silicon Labs" or "Silabs" if the driver is installed correctly.</p>
4	<p>Connect the X2 Wave Flamer via bootloader cable to your PC or Notebook.</p>
5	<p>Open the update file with the bootloader software (File &gt; Select File).</p>
6	<p>Make sure the X2 Wave Flamer is switched off.</p>
7	<p>Start the transfer in the bootloader software (File &gt; Upload).</p>
8	<p>Switch on the X2 Wave Flamer, and wait until the status bar of the programming (green bar) is filled completely.</p> <p>Should the green status bar not appear, it could be due to a faulty connection between the Wave Flamer and Computer.</p>
9	<p>Check the softwares version number in the menu of the device after the update.</p>

# ATTACHMENT 1 – LIST OF SEQUENCES

The opening times of the sequences marked in red can be changed in the AutoShow or ShowCreator. The adjustable opening times can be found in attachment 4.

## SINGLE IGNITIONS

Channel	Ignition	Ignition Time	Description	Movement	Time
1	-105°	110ms(40)	Single Ignition short flame		0,11 Sec.
2	-90°	110ms(40)	Single Ignition short flame		0,11 Sec.
3	-75°	110ms(40)	Single Ignition short flame		0,11 Sec.
4	-60°	110ms(40)	Single Ignition short flame		0,11 Sec.
5	-45°	110ms(40)	Single Ignition short flame		0,11 Sec.
6	-30°	110ms(40)	Single Ignition short flame		0,11 Sec.
7	-15°	110ms(40)	Single Ignition short flame		0,11 Sec.
8	0°	110ms(40)	Single Ignition short flame		0,11 Sec.
9	15°	110ms(40)	Single Ignition short flame		0,11 Sec.
10	30°	110ms(40)	Single Ignition short flame		0,11 Sec.
11	45°	110ms(40)	Single Ignition short flame		0,11 Sec.
12	60°	110ms(40)	Single Ignition short flame		0,11 Sec.
13	75°	110ms(40)	Single Ignition short flame		0,11 Sec.
14	90°	110ms(40)	Single Ignition short flame		0,11 Sec.
15	105°	110ms(40)	Single Ignition short flame		0,11 Sec.
16	-105°	410ms(340)	Single ignition long flame		0,41 Sec.
17	-90°	410ms(340)	Single ignition long flame		0,41 Sec.
18	-75°	410ms(340)	Single ignition long flame		0,41 Sec.
19	-60°	410ms(340)	Single ignition long flame		0,41 Sec.
20	-45°	410ms(340)	Single ignition long flame		0,41 Sec.
21	-30°	410ms(340)	Single ignition long flame		0,41 Sec.
22	-15°	410ms(340)	Single ignition long flame		0,41 Sec.
23	0°	410ms(340)	Single ignition long flame		0,41 Sec.
24	15°	410ms(340)	Single ignition long flame		0,41 Sec.
25	30°	410ms(340)	Single ignition long flame		0,41 Sec.
26	45°	410ms(340)	Single ignition long flame		0,41 Sec.
27	60°	410ms(340)	Single ignition long flame		0,41 Sec.
28	75°	410ms(340)	Single ignition long flame		0,41 Sec.
29	90°	410ms(340)	Single ignition long flame		0,41 Sec.
30	105°	410ms(340)	Single ignition long flame		0,41 Sec.

## STEPP-SEQUENCES

Channel	Ignition	Description	Direction	Time
31	Stepp von 1-15	Stepp short flame	L -> R	2,4 Sec.
32	Stepp von 15-1	Stepp short flame	R -> L	2,4 Sec.
33	Stepp 5 > 8 > 11	Stepp short flame	L -> R	0,58 Sec.
34	Stepp 11 > 8 > 5	Stepp short flame	R -> L	0,58 Sec.
35	Stepp 6 > 10	Stepp short flame	L -> R	0,39 Sec.
36	Stepp 10 > 6	Stepp short flame	R -> L	0,39 Sec.
37	Stepp 4 > 6 > 8 > 10 > 12	Stepp short flame	L -> R	0,9 Sec.
38	Stepp 12 > 10 > 8 > 6 > 4	Stepp short flame	R -> L	0,9 Sec.
39	Stepp 8 > 6 > 10 > 4 > 12	Stepp short flame	M > L > R > L > R	1 Sec.
40	Stepp 8 > 10 > 6 > 12 > 4	Stepp short flame	M > R > L > R > L	1 Sec.
41	Stepp von 1-15	Stepp long flame	L -> R	6,89 Sec.
42	Stepp von 15-1	Stepp long flame	R -> L	6,89 Sec.
43	Stepp 5 > 8 > 11	Stepp long flame	L -> R	1,48 Sec.
44	Stepp 11 > 8 > 5	Stepp long flame	R -> L	1,48 Sec.
45	Stepp 6 > 10	Stepp long flame	L -> R	0,99 Sec.
46	Stepp 10 > 6	Stepp long flame	R -> L	0,99 Sec.
47	Stepp 4 > 6 > 8 > 10 > 12	Stepp long flame	L -> R	2,4 Sec.
48	Stepp 12 > 10 > 8 > 6 > 4	Stepp long flame	R -> L	2,4 Sec.
49	Stepp 8 > 6 > 10 > 4 > 12	Stepp long flame	M > L > R > L > R	2,53 Sec.
50	Stepp 8 > 10 > 6 > 12 > 4	Stepp long flame	M > R > L > R > L	2,53 Sec.

## WAVE-SEQUENCES

Channel	Ignition	Description	Direction	Time
51	Wave 5 --> 11	Wave sequence mid	L -> R	1,79 Sec.
52	Wave 11 --> 5	Wave sequence mid	R -> L	1,79 Sec.
53	BIG WAVE 1 --> 15	Wave sequence long	L -> R	3,93 Sec.
54	BIG WAVE 15 --> 1	Wave sequence long	R -> L	3,93 Sec.
55	Wave 8 --> 1	Wave sequence mid	M -> L	2,26 Sec.
56	Wave 8 --> 15	Wave sequence mid	M -> R	2,26 Sec.
57	Wave 1 --> 8	Wave sequence mid	L -> M	2,26 Sec.
58	Wave 15 --> 8	Wave sequence mid	R -> M	2,26 Sec.
59	Wave 8 --> 11	Wave sequence short	M -> R	1,19 Sec.
60	Wave 8 --> 5	Wave sequence short	M -> L	1,19 Sec.
61	Wave 5 --> 8	Wave sequence short	L -> M	1,19 Sec.
62	Wave 11 --> 8	Wave sequence short	R -> M	1,19 Sec.



## ADDITIONAL SEQUENCES

Channel	Ignition	Description	Direction	Time
63	Stepp 2 > 14	Stepp sequence short flame	L -> R	0,48 Sec.
64	Stepp 14 > 2	Stepp sequence short flame	R -> L	0,48 Sec.
65	Stepp 2 > 14	Stepp sequence long flame	L -> R	1,23 Sec.
66	Stepp 14 > 2	Stepp sequence long flame	R -> L	1,23 Sec.
67	Stepp 8 > 13	Stepp sequence short flame	L -> R	
68	Stepp 13 > 8	Stepp sequence short flame	R -> L	
69	Stepp 8 > 13	Stepp sequence long flame	L -> R	
70	Stepp 13 > 8	Stepp sequence long flame	R -> L	

## ADDITIONAL SEQUENCES (ONLY FOR DMX CONTROL)

The following sequences can only be used for DMX control, since the radio control can only command channels 1-70.

Channel	Ignition	Description	Direction	Time
71	Stepp 8 > 3	Stepp sequence short flame	R -> L	
72	Stepp 3 > 8	Stepp sequence short flame	L -> R	
73	Stepp 8 > 3	Stepp sequence long flame	R -> L	
74	Stepp 3 > 8	Stepp sequence long flame	L -> R	
75	Stepp 3 > 13	Stepp sequence short flame	L -> R	
76	Stepp 13 > 3	Stepp sequence short flame	R -> L	
77	Stepp 2 > 14	Stepp sequence short flame	L -> R	
78	Stepp 14 > 2	Stepp sequence short flame	R -> L	
79	Stepp 8 > 5 > 11	Stepp short flame	M -> L -> R	
80	Stepp 8 > 11 > 5	Stepp short flame	M -> R -> L	
81	Stepp von 5-11	Stepp short flame	L -> R	
82	Stepp von 11-5	Stepp short flame	R -> L	
83	Wave 8 -->13	Wave sequence	M -> R	
84	Wave 13 --> 8	Wave sequence	R -> M	
85	Wave 8 --> 3	Wave sequence	M -> L	
86	Wave 3 --> 8	Wave sequence	L -> M	
87	Wave 3 -->13	Wave sequence	L -> R	
88	Wave 13 --> 3	Wave sequence	R -> L	

STANDARD SETTINGS OF DMX CHANNELS (ONLY EASY-DMX)

DMX channel	Ignition channel	Ignition	Description	Direction
2	17	-90°	Single ignition long flame	
3	19	-60°	Single ignition long flame	
4	21	-30°	Single ignition long flame	
5	23	0°	Single ignition long flame	
6	25	30°	Single ignition long flame	
7	27	60°	Single ignition long flame	
8	29	90°	Single ignition long flame	
9	31	Stepp from 1-15	Stepp short flame	L -> R
10	32	Stepp from 15-1	Stepp short flame	R -> L
11	43	Stepp 5 > 8 > 11	Stepp long flame	L -> R
12	44	Stepp 11 > 8 > 5	Stepp long flame	R -> L
13	55	Wave 8 --> 1	Wave sequence mid	M -> L
14	56	Wave 8 --> 15	Wave sequence mid	M -> R
15	51	Wave 5 --> 11	Wave sequence mid	L -> R
16	52	Wave 11 --> 5	Wave sequence mid	R -> L

# ATTACHMENT 2 - TROUBLESHOOTING

Problem	Possible cause	Possible solution
Wave Flamer doesn't ignite.	Dirty ignition electrode	Clean electrodes with toothbrush
	Defective ignition electrode	Check electrode for any obvious damages. (If damaged – Contact manufacturer)
	Damaged ignition electrode cable.	Check isolation of ignition electrode cables. ( If damaged – Contact manufacturer)
	Other (eg. internal damages to the system)	Contact manufacturer
	Fluid unsuitable for temperatures	Consult MSDS of the fluid and check temperature range.
	Wrongly mounted ignition electrode	Adjust according to attachment 3.
	Clogged nozzle	Dismount nozzle and clean with clear fluid and pressurized air.
Wave Flamer is leaking.	Internal problem	Open side panel, build pressure and find weak spot. Contact manufacturer.
Wave Flamer head is leaking.	Pivot joint leaks	Contact manufacturer. Shipment of spare parts possible.
	Nozzle leaks	Change rubber sealing ring.
Wave Flamer resets.	Power supply inadequate	Check power supply (max. power per Wave Flamer is 350W).
	Defective mains supply	Contact manufacturer
Wave Flamer doesn't pump.	Defective pump	Contact manufacturer .
	Reflux valve jammed	Contact manufacturer (Guide to cleaning the valve possible).
Wave Flamer pumps continuously.	Defective reflux valve	Contact manufacturer .
Wave Flamer head doesn't move.	Defective motor	Contact manufacturer .
Wave Flamer can't be controlled.	Wrong settings	Check usage mode and system settings. Consult manual.
	Defektive radio module	Contact manufacturer .
	Defektive DMX controller or DMX cable	Check DMX hardware.
Display shows an error-code.	System error	Contact manufacturer .
Wave Flamer can't be switched on.	Problem with the power supply	Check supply line (eg damage to power cable or the fuze).
	Internal problem	Contact manufacturer .

Contact the manufacturer: [office@explo.at](mailto:office@explo.at) or by phone at +43(0)463/32 245

# ATTACHMENT 3 – IGNITION ELECTRODES

## IS THE IGNITION SET CORRECTLY?

Set a distance of 10mm and 4mm of the electrodes as pictured.

## ARE THE CERAMICS OR THE ELECTRODES DIRTY?

If strongly soiled, the spark can jump over at another place. Clean the ceramics and the ignition electrodes carefully with an old toothbrush until they are free of dirt and soot.

## IS DIRT INSIDE THE NOZZLE?

Even small parts of dirt can divert the fuel from the nozzle. Unscrew the nozzle from its place and clean it with pressurized air. Also check the threading for dirt.

## IS THE CORRECT FUEL USED?

Use the correct mix of Bioethanol and castor oil. Do not use coloured fluids. Salts can damage the pumps and clog the nozzle.

## IS THE SEALING RING OR THE NOZZLE DAMAGED?

Should the nozzle be damaged, it may lead to a diversion of the fuel ejected.

## ARE THE IGNITION ELECTRODES CABLES DAMAGED?

Check if the cables leading to the ignition are damaged.

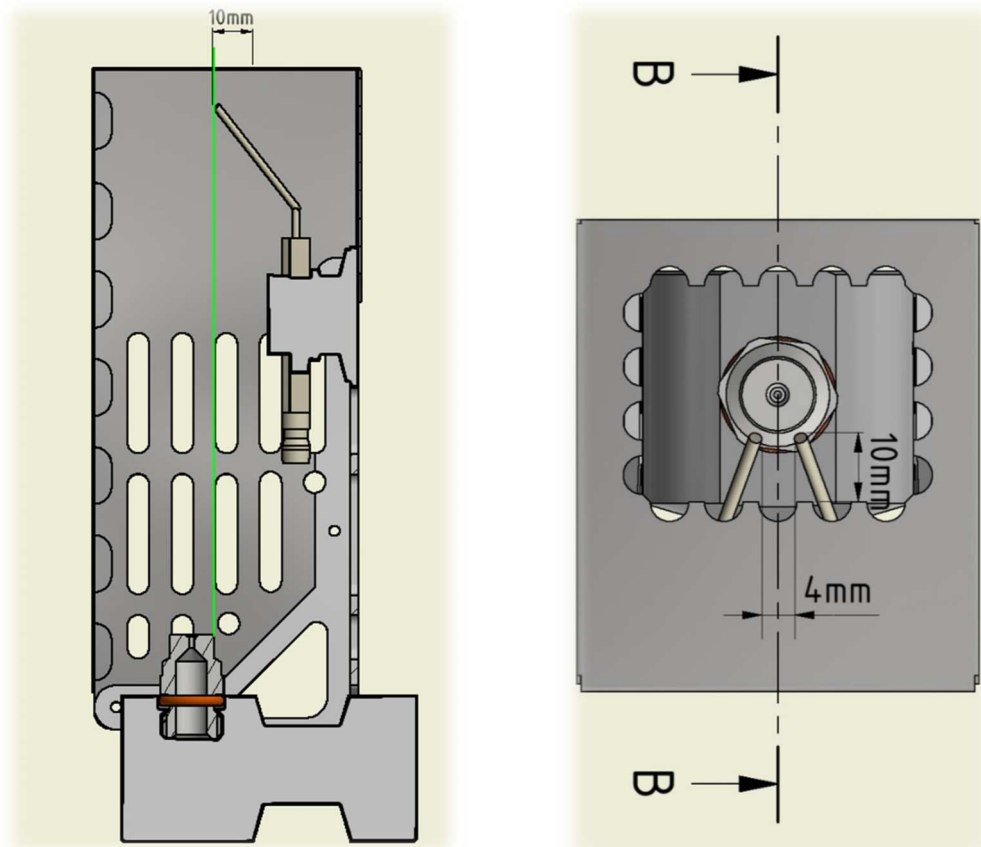

# ATTACHMENT 4 – OPENING TIMES

Below you can find the changeable opening times of the AutoShow and ShowCreator. These times are true for single ignitions. At stepp-sequences, this opening time will be assigned to every stepp-ignition.

Group Letter	Opening time per ignition
<b>a</b>	Standard setting
<b>b</b>	20ms
<b>c</b>	30ms
<b>d</b>	40ms
<b>e</b>	50ms
<b>f</b>	60ms
<b>g</b>	70ms
<b>h</b>	80ms
<b>i</b>	90ms
<b>j</b>	100ms
<b>k</b>	200ms
<b>l</b>	300ms
<b>m</b>	400ms
<b>n</b>	500ms
<b>o</b>	600ms
<b>p</b>	700ms
<b>q</b>	800ms
<b>r</b>	900ms
<b>s</b>	1.000ms
<b>t</b>	1.500ms
<b>u</b>	2.000ms
<b>v</b>	2.500ms
<b>w</b>	3.000ms
<b>x</b>	Standard setting
<b>y</b>	Standard setting
<b>z</b>	Standard setting